

User Manual



TDS1000- and TDS2000-Series Digital Storage Oscilloscope

071-1064-00

This document supports firmware version
FV:v1.00 and above.

www.tektronix.com

Copyright © Tektronix, Inc. All rights reserved.

Tektronix products are covered by U.S. and foreign patents, issued and pending. Information in this publication supercedes that in all previously published material. Specifications and price change privileges reserved.

Tektronix, Inc., P.O. Box 500, Beaverton, OR 97077

TEKTRONIX and TEK are registered trademarks of Tektronix, Inc.

WARRANTY SUMMARY
(TDS1000- and TDS2000-Series Digital Storage Oscilloscope)

Tektronix warrants that the products that it manufactures and sells will be free from defects in materials and workmanship for a period of three (3) years from the date of shipment from an authorized Tektronix distributor. If a product or CRT proves defective within the respective period, Tektronix will provide repair or replacement as described in the complete warranty statement.

To arrange for service or obtain a copy of the complete warranty statement, please contact your nearest Tektronix sales and service office.

EXCEPT AS PROVIDED IN THIS SUMMARY OR THE APPLICABLE WARRANTY STATEMENT, TEKTRONIX MAKES NO WARRANTY OF ANY KIND, EXPRESS OR IMPLIED, INCLUDING WITHOUT LIMITATION THE IMPLIED WARRANTIES OF MERCHANTABILITY AND FITNESS FOR A PARTICULAR PURPOSE. IN NO EVENT SHALL TEKTRONIX BE LIABLE FOR INDIRECT, SPECIAL OR CONSEQUENTIAL DAMAGES.

WARRANTY SUMMARY
(P2200 Probe)

Tektronix warrants that the products that it manufactures and sells will be free from defects in materials and workmanship for a period of one (1) year from the date of shipment. If a product proves defective within the respective period, Tektronix will provide repair or replacement as described in the complete warranty statement.

To arrange for service or obtain a copy of the complete warranty statement, please contact your nearest Tektronix sales and service office.

EXCEPT AS PROVIDED IN THIS SUMMARY OR THE APPLICABLE WARRANTY STATEMENT, TEKTRONIX MAKES NO WARRANTY OF ANY KIND, EXPRESS OR IMPLIED, INCLUDING WITHOUT LIMITATION THE IMPLIED WARRANTIES OF MERCHANTABILITY AND FITNESS FOR A PARTICULAR PURPOSE. IN NO EVENT SHALL TEKTRONIX BE LIABLE FOR INDIRECT, SPECIAL OR CONSEQUENTIAL DAMAGES.



Table of Contents

General Safety Summary	v
Preface	vii
Help System	ix
Conventions	xi
Product End-of-Life Handling	xii
Contacting Tektronix	xiii
Getting Started	1
General Features	2
Installation	4
Power Cord	4
Security Loop	4
Functional Check	5
Probe Safety	6
Probe Check Wizard	7
Manual Probe Compensation	8
Probe Attenuation Setting	9
Self Calibration	10
Understanding Oscilloscope Functions	11
Setting Up the Oscilloscope	12
Using Autoset	12
Saving a Setup	12
Recalling a Setup	12
Default Setup	13
Triggering	13
Source	14
Types	15
Modes	15
Coupling	15
Position	16
Slope and Level	16

Acquiring Signals	17
Acquisition Modes	17
Time Base	18
Scaling and Positioning Waveforms	18
Vertical Scale and Position	18
Horizontal Scale and Position; Pretrigger Information	19
Taking Measurements	24
Graticule	24
Cursors	25
Automatic	25
Operating Basics	27
Display Area	28
Message Area	31
Using the Menu System	32
Vertical Controls	34
Horizontal Controls	35
Trigger Controls	36
Menu and Control Buttons	38
Connectors	39
Application Examples	41
Taking Simple Measurements	42
Using Autoset	42
Taking Automatic Measurements	43
Measuring Two Signals	46
Taking Cursor Measurements	48
Measuring Ring Frequency	48
Measuring Ring Amplitude	49
Measuring Pulse Width	50
Measuring Rise Time	51
Analyzing Signal Detail	54
Looking at a Noisy Signal	54
Separating the Signal from Noise	55
Capturing a Single-Shot Signal	56
Optimizing the Acquisition	57
Measuring Propagation Delay	58

Triggering on a Specific Pulse Width	60
Triggering on a Video Signal	62
Triggering on Video Fields	63
Triggering on Video Lines	64
Using the Window Function to See Waveform Details	66
Analyzing a Differential Communication Signal	68
Viewing Impedance Changes in a Network	70
Reference	73
Acquire	74
Autoset	79
Sine Wave	81
Square Wave or Pulse	82
Video Signal	83
Cursors	84
Default Setup	85
Display	86
Help	89
Horizontal	90
Math	93
Measure	94
Print	96
Probe Check	96
Save/Recall	97
Trigger Controls	99
Utility	110
Vertical	112
Math FFT	115
Setting Up the Time-Domain Waveform	116
Displaying the FFT Spectrum	118
Selecting an FFT Window	120
Magnifying and Positioning an FFT Spectrum	124
Measuring an FFT Spectrum Using Cursors	126

TDS2CMA Communications Module	127
Installing and Removing an Extension Module	127
Checking Module Installation	130
Troubleshooting Module Installation	130
Sending Screen Data to an External Device	131
Setting Up and Testing the RS-232 Interface	134
Transferring Binary Data	141
Reporting RS-232 I/O Errors	141
Setting Up and Testing the GPIB Interface	143
Command Entry	150
Appendix A: Specifications	151
Appendix B: Accessories	169
Appendix C: General Care and Cleaning	173
Appendix D: Default Setup	175
Appendix E: GPIB and RS-232 Interfaces	179
Index	181

General Safety Summary

Review the following safety precautions to avoid injury and prevent damage to this product or any products connected to it. To avoid potential hazards, use this product only as specified.

Only qualified personnel should perform service procedures.

To Avoid Fire or Personal Injury

Use Proper Power Cord. Use only the power cord specified for this product and certified for the country of use.

Connect and Disconnect Properly. Do not connect or disconnect probes or test leads while they are connected to a voltage source.

Ground the Product. This product is grounded through the grounding conductor of the power cord. To avoid electric shock, the grounding conductor must be connected to earth ground. Before making connections to the input or output terminals of the product, ensure that the product is properly grounded.

Connect the Probe Properly. The probe ground lead is at ground potential. Do not connect the ground lead to an elevated voltage.

Observe All Terminal Ratings. To avoid fire or shock hazard, observe all ratings and marking on the product. Consult the product manual for further ratings information before making connections to the product.

Do Not Operate Without Covers. Do not operate this product with covers or panels removed.

Use Proper Fuse. Use only the fuse type and rating specified for this product.

Avoid Exposed Circuitry. Do not touch exposed connections and components when power is present.

Do Not Operate With Suspected Failures. If you suspect there is damage to this product, have it inspected by qualified service personnel.

Provide Proper Ventilation. Refer to the manual's installation instructions for details on installing the product so it has proper ventilation.

Do Not Operate in Wet/Damp Conditions.

Do Not Operate in an Explosive Atmosphere.

Keep Product Surfaces Clean and Dry.

Safety Terms and Symbols

Terms in This Manual. These terms may appear in this manual:



WARNING. *Warning statements identify conditions or practices that could result in injury or loss of life.*



CAUTION. *Caution statements identify conditions or practices that could result in damage to this product or other property.*

Terms on the Product. These terms may appear on the product:

DANGER indicates an injury hazard immediately accessible as you read the marking.

WARNING indicates an injury hazard not immediately accessible as you read the marking.

CAUTION indicates a hazard to property including the product.

Symbols on the Product. These symbols may appear on the product:



Protective Ground
(Earth) Terminal



Measurement
Ground Terminal



CAUTION
Refer to Manual



Measurement
Input Terminal



Mains Disconnected
OFF (Power)



Mains Connected
ON (Power)



Preface

This manual contains operating information for the TDS1000-Series and TDS2000-Series Digital Storage Oscilloscopes. The manual consists of the following chapters:

- The *Getting Started* chapter briefly describes features of the oscilloscope and provides installation instructions.
- The *Understanding Oscilloscope Functions* chapter describes basic operations and functions of the oscilloscope: setting up the oscilloscope, triggering, acquiring data, scaling and positioning waveforms, and taking measurements.
- The *Operating Basics* chapter covers operating principles of the oscilloscope.
- The *Application Examples* chapter includes examples of a wide variety of measurements to give you ideas on how to solve your own measurement problems.
- The *Reference* chapter describes the selections or available range of values for each option.

- The *Math FFT* chapter contains detailed information about how to use the Math FFT function.
- The *TDS2CMA Communications Module* chapter describes this optional module and how to set up the RS-232, GPIB, and Centronics ports to use the oscilloscope with external devices, such as printers and computers.
- The *Appendix A: Specifications* chapter includes electrical, environmental, and physical specifications for the oscilloscope, as well as certifications and compliances.
- The *Appendix B: Accessories* chapter briefly describes standard and optional accessories.
- The *Appendix C: General Care and Cleaning* chapter describes how to take care of the oscilloscope.
- The *Appendix D: Default Setup* chapter contains a list of the menus and controls with the default (factory) settings that are recalled when you push the DEFAULT SETUP front-panel button.
- The *Appendix E: GPIB and RS-232 Interfaces* chapter compares the two protocols to help you decide which one to use.

Help System

The oscilloscope has a Help system with topics that cover all the features of the oscilloscope. You can use the Help system to display several kinds of information:

- General information about understanding and using the oscilloscope, such as Using the Menu System.
- Information about specific menus and controls, such as the Vertical Position Control.
- Advice about problems you may face while using an oscilloscope, such as Reducing Noise.

The Help system provides three ways for you to find the information you need: context-sensitive, hyperlinks, and an index.

Context-Sensitive

The oscilloscope displays information about the last menu displayed on the screen when you push the HELP front-panel button. The HELP SCROLL LED lights under the HORIZONTAL POSITION knob to indicate the alternative function of the knob. If the topic uses more than one page, turn the HELP SCROLL knob to move from page to page within the topic.

Hyperlinks

Most of the help topics contain phrases marked with angle brackets, such as <Autoset>. These are links to other topics. Turn the HELP SCROLL knob to move the highlight from one link to another. Push the Show Topic option button to display the topic corresponding to the highlighted link. Push the Back option button to return to the previous topic.

Index

Push the front-panel HELP button, then push the Index option button. Push the Page Up or Page Down option buttons until you find the index page that contains the topic you want to view. Turn the HELP SCROLL knob to highlight a help topic. Push the Show Topic option button to display the topic.

NOTE. *Push the Exit option button or any menu button to remove the Help text from the screen and return to displaying waveforms.*

Conventions

This manual uses the following conventions:

- Front-panel buttons, knobs and connectors appear in all uppercase letters. For example: HELP, PRINT.
- Menu options appear with the first letter of each word in upper case. For example: Peak Detect, Window Zone.

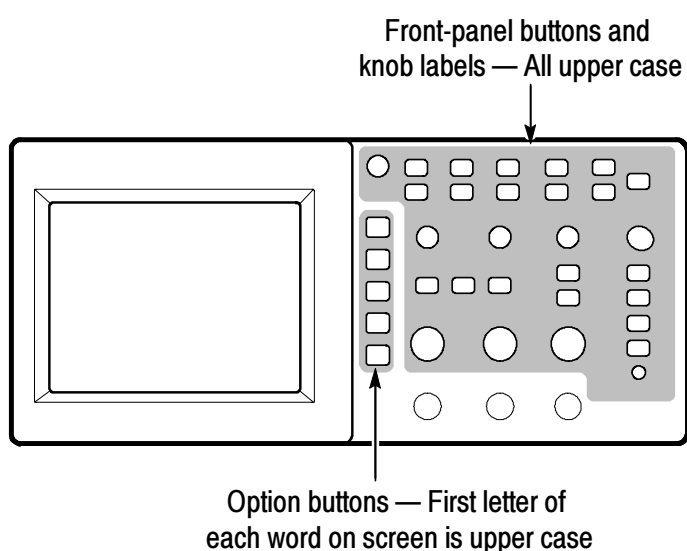

NOTE. *Option buttons can also be called screen buttons, side-menu buttons, bezel buttons, or soft keys.*

- The ► delimiter separates a series of button pushes. For example, UTILITY ► Options ► RS-232 means that you push the UTILITY button, then push the Options option button, and then push the RS-232 option button.

Product End-of-Life Handling

Components that Contain Mercury. The cold cathode fluorescent tube located in the liquid crystal display backlight contains trace amounts of mercury. When you are ready to reclaim the instrument, you must properly transfer it according to local regulations concerning mercury-containing equipment or ship the instrument to the Tektronix Recycling Operations (RAMS). You can contact Tektronix for the RAMS shipping address and instructions.

Contacting Tektronix

Phone	1-800-833-9200*
Address	Tektronix, Inc. Department or name (if known) 14200 SW Karl Braun Drive P.O. Box 500 Beaverton, OR 97077 USA
Web site	www.tektronix.com
Sales support	1-800-833-9200, select option 1*
Service support	1-800-833-9200, select option 2*
Technical support	Email: techsupport@tektronix.com 1-800-833-9200, select option 3* 6:00 a.m. - 5:00 p.m. Pacific time

* **This phone number is toll free in North America. After office hours, please leave a voice mail message. Outside North America, contact a Tektronix sales office or distributor; see the Tektronix web site for a list of offices.**

Getting Started

TDS1000-Series and TDS2000-Series Digital Storage Oscilloscopes are small, lightweight, benchtop packages that you can use to take ground-referenced measurements.

In addition to the list of general features, this chapter describes how to do the following tasks:

- Install your product
- Perform a brief functional check
- Perform a probe check and compensate probes
- Match your probe attenuation factor
- Use the self calibration routine

NOTE. *You can select a language to display on the screen when you power on the oscilloscope. At any time, you can push the **UTILITY** button, and push the **Language option** button to select a language.*

General Features

The next table and bulleted list describe the general features.

Model	Channels	Bandwidth	Sample rate	Display
TDS1002	2	60 MHz	1.0 GS/s	Monochrome
TDS1012	2	100 MHz	1.0 GS/s	Monochrome
TDS2002	2	60 MHz	1.0 GS/s	Color
TDS2012	2	100 MHz	1.0 GS/s	Color
TDS2014	4	100 MHz	1.0 GS/s	Color
TDS2022	2	200 MHz	2.0 GS/s	Color
TDS2024	4	200 MHz	2.0 GS/s	Color

- Context-sensitive Help system
- Color or monochrome LCD display
- Selectable 20 MHz bandwidth limit
- 2500 point record length for each channel
- Autoset Menu
- Probe Check Wizard
- Cursors with readouts
- Trigger frequency readout
- Eleven automatic measurements
- Waveform averaging and peak detection

- Dual time base
- Math Fast Fourier Transform (FFT)
- Pulse Width trigger capability
- Video trigger capability with line-selectable triggering
- External trigger
- Setup and waveform storage
- Variable persistence display
- RS-232, GPIB, and Centronics ports with the optional TDS2CMA Communications Extension Module
- User interface in ten user-selectable languages

Installation

Power Cord

Use only power cords designed for your oscilloscope. Use a power source that delivers 90 to 264 VAC_{RMS}, 45 to 66 Hz. If you have a 400 Hz power source, it must deliver 90 to 132 VAC_{RMS}, 360 to 440 Hz. Refer to page 171 for a list of available power cords.

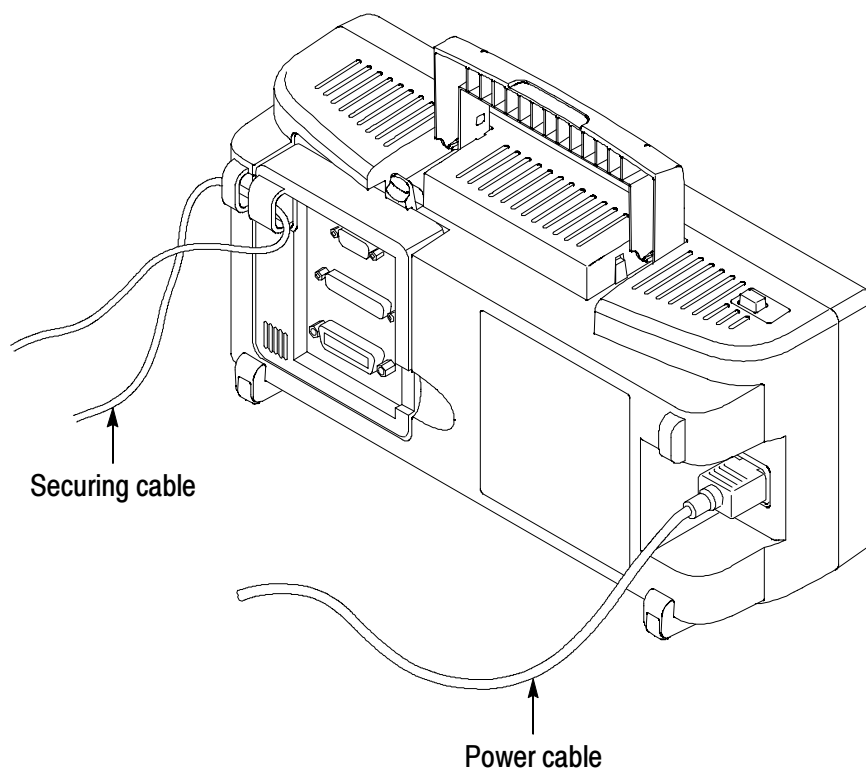

Security Loop

Use the built-in cable channels to secure both your oscilloscope and extension module to your location.

Functional Check

Perform this quick functional check to verify that your oscilloscope is operating correctly.

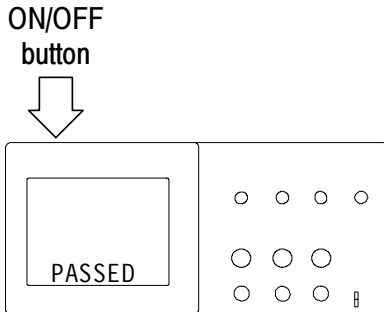

1. Power on the oscilloscope.

Wait until the display shows that all power-on tests passed. Push the **DEFAULT SETUP** button. The default Probe option attenuation setting is 10X.

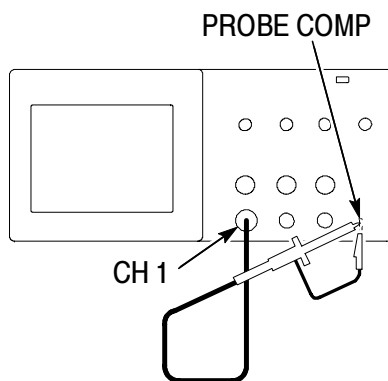

2. Set the switch to 10X on the P2200 probe and connect the probe to channel 1 on the oscilloscope. To do this, align the slot in the probe connector with the key on the CH 1 BNC, push to connect, and twist to the right to lock the probe in place.

Connect the probe tip and reference lead to the **PROBE COMP** connectors.

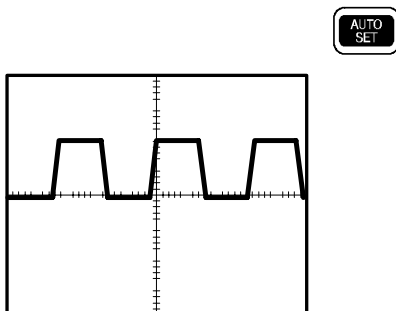

3. Push the **AUTOSET** button. Within a few seconds, you should see a square wave in the display of about 5 V peak-to-peak at 1 kHz.

Push the **CH 1 MENU** button twice to remove channel 1, push the **CH 2 MENU** button to display channel 2, repeat steps 2 and 3. For 4-channel models, repeat for **CH 3** and **CH 4**.

Probe Safety

A guard around the probe body provides a finger barrier for protection from electric shock.

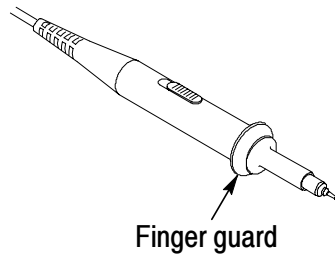

WARNING. *To avoid electric shock when using the probe, keep fingers behind the guard on the probe body.*

To avoid electric shock while using the probe, do not touch metallic portions of the probe head while it is connected to a voltage source.

Connect the probe to the oscilloscope and connect the ground terminal to ground before you take any measurements.

Probe Check Wizard

You can use the Probe Check Wizard to quickly verify that your probe is operating properly. The wizard also helps you adjust the probe compensation (usually adjusted with a screw on the probe body or probe connector) and set the Probe option attenuation factor in the vertical menu (for example, the menu that appears when you push the CH 1 MENU button).

You should do this each time you connect a probe to an input channel.

To use the Probe Check Wizard, push the PROBE CHECK button. If your probe is connected properly, compensated properly, and the Probe entry in the oscilloscope VERTICAL menu is set to match your probe, the oscilloscope will display a PASSED message at the bottom of the screen. Otherwise, the oscilloscope will display directions on the screen to guide you in correcting these problems.

NOTE. *Probe check is useful for 1X, 10X, and 100X probes; it does not work with the EXT TRIG front-panel BNC.*

To compensate a probe connected to the EXT TRIG front-panel BNC, follow these steps:

1. Connect the probe to any channel BNC, such as to CH 1.
2. Push the PROBE CHECK button and follow the directions on the screen.
3. After you verify that the probe functions properly and is compensated, connect the probe to the EXT TRIG BNC.

Manual Probe Compensation

As an alternative method to Probe Check, you can manually perform this adjustment to match your probe to the input channel.

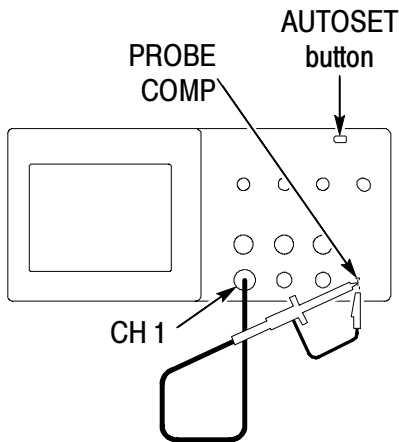

1. Set the Probe option attenuation in the channel menu to 10X. Set the switch to 10X on the P2200 probe and connect the probe to channel 1 on the oscilloscope. If you use the probe hook-tip, ensure a proper connection by firmly inserting the tip onto the probe.
2. Attach the probe tip to the PROBE COMP ~5V connector and the reference lead to the PROBE COMP Ground connector. Display the channel and then push the AUTOSET button.



Overcompensated



Undercompensated



Compensated correctly

3. Check the shape of the displayed waveform.

4. If necessary, adjust your probe.

Repeat as necessary.

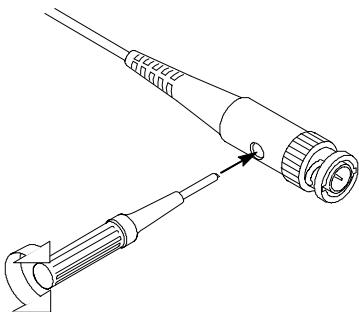

Probe Attenuation Setting

Probes are available with various attenuation factors which affect the vertical scale of the signal. The Probe Check function verifies that the Probe attenuation option matches the attenuation of the probe.

As an alternative method to Probe Check, you can push a vertical menu button (such as the CH 1 MENU button), and select the Probe option that matches the attenuation factor of your probe.

NOTE. *The default setting for the Probe option is 10X.*

Be sure that the Attenuation switch on the P2200 probe matches the Probe option in the oscilloscope. Switch settings are 1X and 10X.

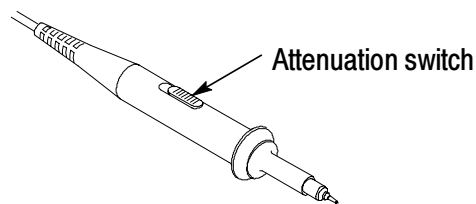

NOTE. *When the Attenuation switch is set to 1X, the P2200 probe limits the bandwidth of the oscilloscope to 7 MHz. To use the full bandwidth of the oscilloscope, be sure to set the switch to 10X.*

Self Calibration

The self calibration routine lets you optimize the oscilloscope signal path for maximum measurement accuracy. You can run the routine at any time but should always run the routine if the ambient temperature changes by 5° C or more.

To compensate the signal path, disconnect any probes or cables from the front-panel input connectors. Then, push the UTILITY button, select the Do Self Cal option and follow the directions on the screen.

Understanding Oscilloscope Functions

This chapter contains information on what you need to understand before you use an oscilloscope. To use your oscilloscope effectively, you need to learn about the following oscilloscope functions:

- Setting up the oscilloscope
- Triggering
- Acquiring signals (waveforms)
- Scaling and positioning waveforms
- Measuring waveforms

The figure below shows a block diagram of the various functions of the oscilloscope and their relationship to each other.

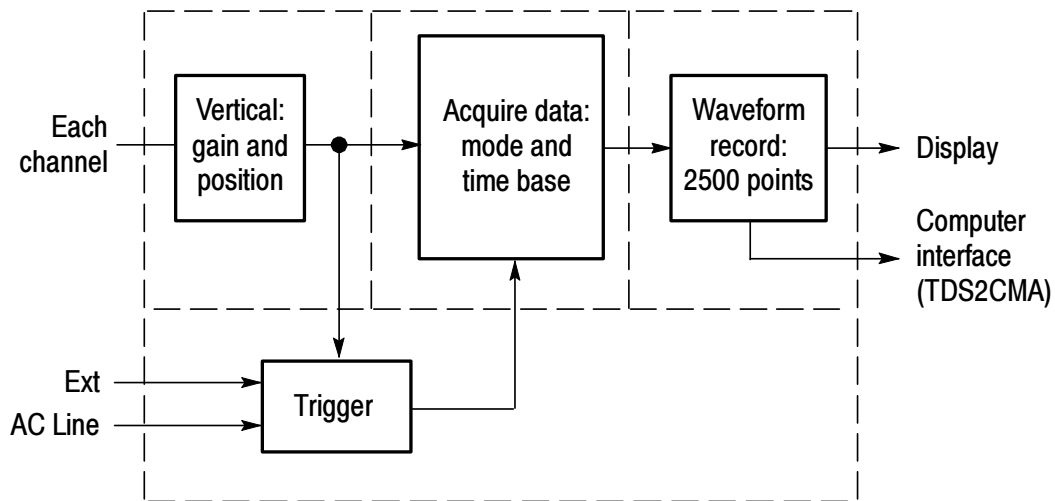

Setting Up the Oscilloscope

You should become familiar with three functions that you may use often when operating your oscilloscope: Autoset, saving a setup, and recalling a setup.

Using Autoset

The Autoset function obtains a stable waveform display for you. It automatically adjusts the vertical scale, horizontal scale and trigger settings. Autoset also displays several automatic measurements in the graticule area, depending on the signal type.

Saving a Setup

The oscilloscope saves the current setup if you wait five seconds after the last change before you power off the oscilloscope. The oscilloscope recalls this setup the next time you apply power.

You can use the SAVE/RECALL Menu to permanently save up to ten different setups.

Recalling a Setup

The oscilloscope can recall the last setup before power off, any of your saved setups or the default setup. See page 175.

Default Setup

The oscilloscope is set up for normal operation when it is shipped from the factory. This is the default setup. To recall this setup, push the DEFAULT SETUP button. To view the default settings, refer to *Appendix D: Default Setup*.

Triggering

The trigger determines when the oscilloscope starts to acquire data and display a waveform. When a trigger is set up properly, the oscilloscope converts unstable displays or blank screens into meaningful waveforms.

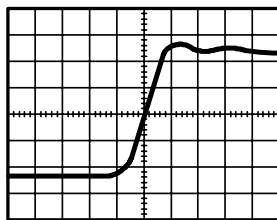

Triggered waveform

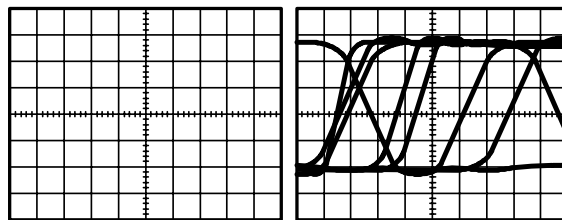

Untriggered waveforms

For oscilloscope-specific descriptions, refer to page 36 in the *Operating Basics* chapter and page 99 in the *Reference* chapter.

When you push the RUN/STOP or SINGLE SEQ buttons to start an acquisition, the oscilloscope goes through the following steps:

1. Acquires enough data to fill the portion of the waveform record to the left of the trigger point. This is also called the pretrigger.
2. Continues to acquire data while waiting for the trigger condition to occur.
3. Detects the trigger condition.
4. Continues to acquire data until the waveform record is full.
5. Displays the newly-acquired waveform.

NOTE. *For Edge and Pulse triggers, the oscilloscope counts the rate at which trigger events occur to determine trigger frequency and displays the frequency in the lower right corner of the screen.*

Source

You can use the Trigger Source options to select the signal that the oscilloscope uses as a trigger. The source can be any signal connected to a channel BNC, to the EXT TRIG BNC or the AC power line (available only with Edge triggers).

Types

The oscilloscope provides three types of triggers: Edge, Video, and Pulse Width.

Modes

You can select a Trigger Mode to define how the oscilloscope acquires data when it does not detect a trigger condition. The modes are Auto and Normal.

To perform a single sequence acquisition, push the SINGLE SEQ button.

Coupling

You can use the Trigger Coupling option to determine which part of the signal will pass to the trigger circuit. This can help you attain a stable display of the waveform.

To use trigger coupling, push the TRIG MENU button, select an Edge or Pulse trigger, and select a Coupling option.

NOTE. *Trigger coupling affects only the signal passed to the trigger system. It does not affect the bandwidth or coupling of the signal displayed on the screen.*

To view the conditioned signal being passed to the trigger circuit, push and hold down the TRIG VIEW button.

Position

The horizontal position control establishes the time between the trigger and the screen center. Refer to *Horizontal Scale and Position; Pretrigger Information* on page 19 for more information on how to use this control to position the trigger.

Slope and Level

The Slope and Level controls help to define the trigger. The Slope option (Edge trigger type only) determines whether the oscilloscope finds the trigger point on the rising or the falling edge of a signal. The TRIGGER LEVEL knob controls where on the edge the trigger point occurs.

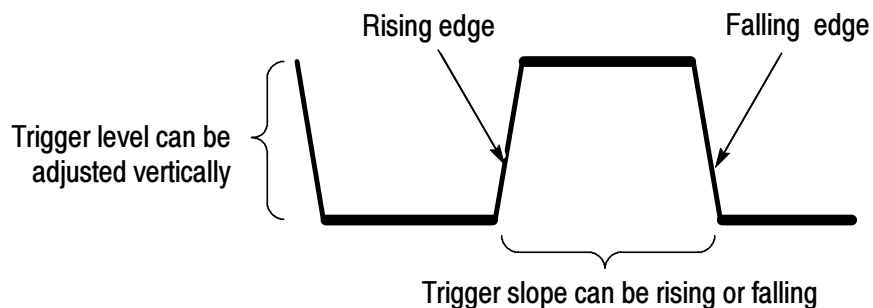

Acquiring Signals

When you acquire a signal, the oscilloscope converts it into a digital form and displays a waveform. The acquisition mode defines how the signal is digitized and the time base setting affects the time span and level of detail in the acquisition.

Acquisition Modes

There are three acquisition modes: Sample, Peak Detect, and Average.

Sample. In this acquisition mode, the oscilloscope samples the signal in evenly spaced intervals to construct the waveform. This mode accurately represents signals most of the time.

However, this mode does not acquire rapid variations in the signal that may occur between samples. This can result in aliasing (described on page 20) and may cause narrow pulses to be missed. In these cases, you should use the Peak Detect mode to acquire data.

Peak Detect. In this acquisition mode, the oscilloscope finds the highest and lowest values of the input signal over each sample interval and uses these values to display the waveform. In this way, the oscilloscope can acquire and display narrow pulses, which may have otherwise been missed in Sample mode. Noise will appear to be higher in this mode.

Average. In this acquisition mode, the oscilloscope acquires several waveforms, averages them, and displays the resulting waveform. You can use this mode to reduce random noise.

Time Base

The oscilloscope digitizes waveforms by acquiring the value of an input signal at discrete points. The time base allows you to control how often the values are digitized.

To adjust the time base to a horizontal scale that suits your purpose, use the SEC/DIV knob.

Scaling and Positioning Waveforms

You can change the display of waveforms by adjusting their scale and position. When you change the scale, the waveform display will increase or decrease in size. When you change the position, the waveform will move up, down, right, or left.

The channel reference indicator (located on the left of the graticule) identifies each waveform on the display. The indicator points to the ground level of the waveform record.

To view the display area and readouts, refer to page 28.

Vertical Scale and Position

You can change the vertical position of waveforms by moving them up or down in the display. To compare data, you can align a waveform above another or you can align waveforms on top of each other.

You can change the vertical scale of a waveform. The waveform display will contract or expand about the ground level.

For oscilloscope-specific descriptions, refer to page 34 in the *Operating Basics* chapter and page 112 in the *Reference* chapter.

Horizontal Scale and Position; Pretrigger Information

You can adjust the HORIZONTAL POSITION control to view waveform data before the trigger, after the trigger, or some of each. When you change the horizontal position of a waveform, you are actually changing the time between the trigger and the center of the display. (This appears to move the waveform to the right or left on the display.)

For example, if you want to find the cause of a glitch in your test circuit, you might trigger on the glitch and make the pretrigger period large enough to capture data before the glitch. You can then analyze the pretrigger data and perhaps find the cause of the glitch.

You change the horizontal scale of all the waveforms by turning the SEC/DIV knob. For example, you might want to see just one cycle of a waveform to measure the overshoot on its rising edge.

The oscilloscope shows the horizontal scale as time per division in the scale readout. Since all active waveforms use the same time base, the oscilloscope only displays one value for all the active channels, except when you use Window Zone. For information on how to use the window function, refer to page 92.

For oscilloscope-specific descriptions, refer to page 35 in the *Operating Basics* chapter and page 90 in the *Reference* chapter.

Time Domain Aliasing. Aliasing occurs when the oscilloscope does not sample the signal fast enough to construct an accurate waveform record. When this happens, the oscilloscope displays a waveform with a frequency lower than the actual input waveform, or triggers and displays an unstable waveform.

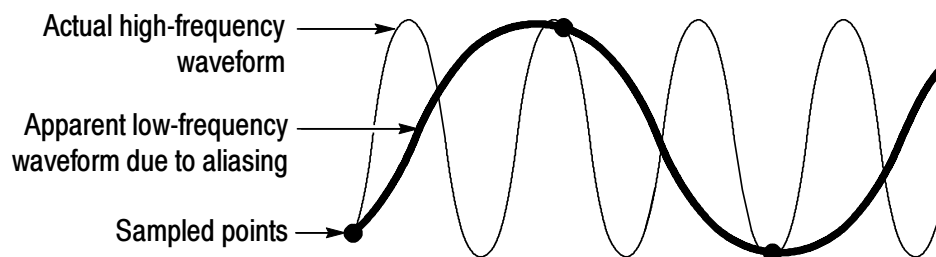

The oscilloscope accurately represents signals, but is limited by the probe bandwidth, the oscilloscope bandwidth, and the sample rate. To avoid aliasing, the oscilloscope must sample the signal more than twice as fast as the highest frequency component of the signal.

The highest frequency that the oscilloscope sampling rate can theoretically represent is the Nyquist frequency. The sample rate is called the Nyquist rate, and is twice the Nyquist frequency.

Oscilloscope models with 60 MHz or 100 MHz bandwidth sample at rates up to 1 GS/s. Models with 200 MHz bandwidth sample at rates up to 2 GS/s. In both cases, these maximum sample rates are at least ten times the bandwidth. These high sample rates help reduce the possibility of aliasing.

There are several ways to check for aliasing:

- Turn the SEC/DIV knob to change the horizontal scale. If the shape of the waveform changes drastically, you may have aliasing.
- Select the Peak Detect acquisition mode (described on page 17). This mode samples the highest and lowest values so that the oscilloscope can detect faster signals. If the shape of the waveform changes drastically, you may have aliasing.
- If the trigger frequency is faster than the display information, you may have aliasing or a waveform that crosses the trigger level multiple times. Examining the waveform should allow identifying whether the shape of the signal is going to allow a single trigger crossing per cycle at the selected trigger level. If multiple triggers are likely to occur, select a trigger level that will generate only a single trigger per cycle. If the trigger frequency is still faster than the display indicates, you may have aliasing.

If the trigger frequency is slower, this test is not useful.

- If the signal you are viewing is also the trigger source, use the graticule or the cursors to estimate the frequency of the displayed waveform. Compare this to the Trigger Frequency readout in the lower right corner of the screen. If they differ by a large amount, you may have aliasing.

The next table lists the time bases that you should use to avoid aliasing at various frequencies and the respective sample rate. At the fastest SEC/DIV setting, aliasing is not likely to occur due to the bandwidth limitations of the oscilloscope input amplifiers.

Settings to avoid aliasing in Sample mode

Time base (SEC/DIV)	Samples per second	Maximum frequency component
25 to 250.0 ns	1 GS/s or 2 GS/s*	200.0 MHz**
500.0 ns	500.0 MS/s	200.0 MHz**
1.0 μ s	250.0 MS/s	125.0 MHz**
2.5 μ s	100.0 MS/s	50.0 MHz**
5.0 μ s	50.0 MS/s	25.0 MHz**
10.0 μ s	25.0 MS/s	12.5 MHz**
25.0 μ s	10.0 MS/s	5.0 MHz
50.0 μ s	5.0 MS/s	2.5 MHz
100.0 μ s	2.5 MS/s	1.25 MHz
250.0 μ s	1.0 MS/s	500.0 kHz
500.0 μ s	500.0 kS/s	250.0 kHz

* Depending on the oscilloscope model.

** Bandwidth reduced to 6 MHz with a 1X probe.

Settings to avoid aliasing in Sample mode (Cont.)

Time base (SEC/DIV)	Samples per second	Maximum frequency component
1.0 ms	250.0 kS/s	125.0 kHz
2.5 ms	100.0 kS/s	50.0 kHz
5.0 ms	50.0 kS/s	25.0 kHz
10.0 ms	25.0 kS/s	12.5 kHz
25.0 ms	10.0 kS/s	5.0 kHz
50.0 ms	5.0 kS/s	2.5 kHz
100.0 ms	2.5 kS/s	1.25 kHz
250.0 ms	1.0 kS/s	500.0 Hz
500.0 ms	500.0 S/s	250.0 Hz
1.0 s	250.0 S/s	125.0 Hz
2.5 s	100.0 S/s	50.0 Hz
5.0 s	50.0 S/s	25.0 Hz
10.0 s	25.0 S/s	12.5 Hz
25.0 s	10.0 S/s	5.0 Hz
50.0 s	5.0 S/s	2.5 Hz

Taking Measurements

The oscilloscope displays graphs of voltage versus time and can help you to measure the displayed waveform.

There are several ways to take measurements. You can use the graticule, the cursors, or an automated measurement.

Graticule

This method allows you to make a quick, visual estimate. For example, you might look at a waveform amplitude and determine that it is a little more than 100 mV.

You can take simple measurements by counting the major and minor graticule divisions involved and multiplying by the scale factor.

For example, if you counted five major vertical graticule divisions between the minimum and maximum values of a waveform and knew you had a scale factor of 100 mV/division, then you could easily calculate your peak-to-peak voltage as follows:

$$5 \text{ divisions} \times 100 \text{ mV/division} = 500 \text{ mV.}$$

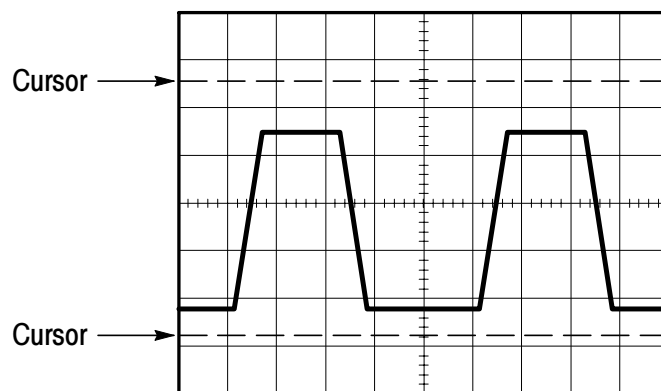

Cursors

This method allows you to take measurements by moving the cursors, which always appear in pairs, and reading their numeric values from the display readouts. There are two types of cursors: Voltage and Time.

When you use cursors, be sure to set the Source to the waveform on the display that you want to measure.

To use cursors, push the CURSOR button.

Voltage Cursors. Voltage cursors appear as horizontal lines on the display and measure the vertical parameters.

Time Cursors. Time cursors appear as vertical lines on the display and measure the horizontal parameters.

Automatic

The MEASURE Menu can take up to five automatic measurements. When you take automatic measurements, the oscilloscope does all the calculating for you. Because the measurements use the waveform record points, they are more accurate than the graticule or cursor measurements.

Automatic measurements use readouts to show measurement results. These readouts are updated periodically as the oscilloscope acquires new data.

For measurement descriptions, refer to page 94 in the *Reference* chapter.

Operating Basics

The front panel is divided into easy-to-use functional areas. This chapter provides you with a quick overview of the controls and the information displayed on the screen. The next figure shows the front panels for 2-channel and 4-channel models.

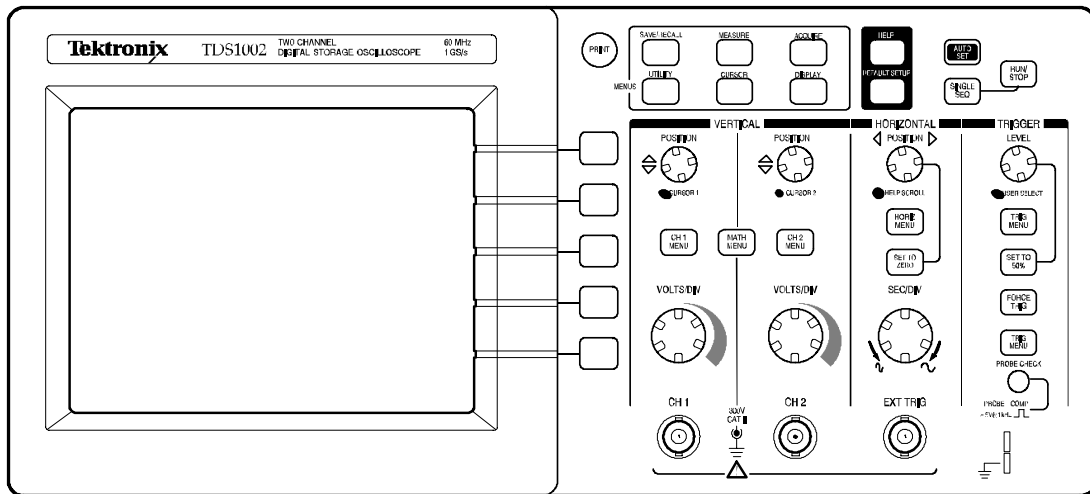

2-channel models

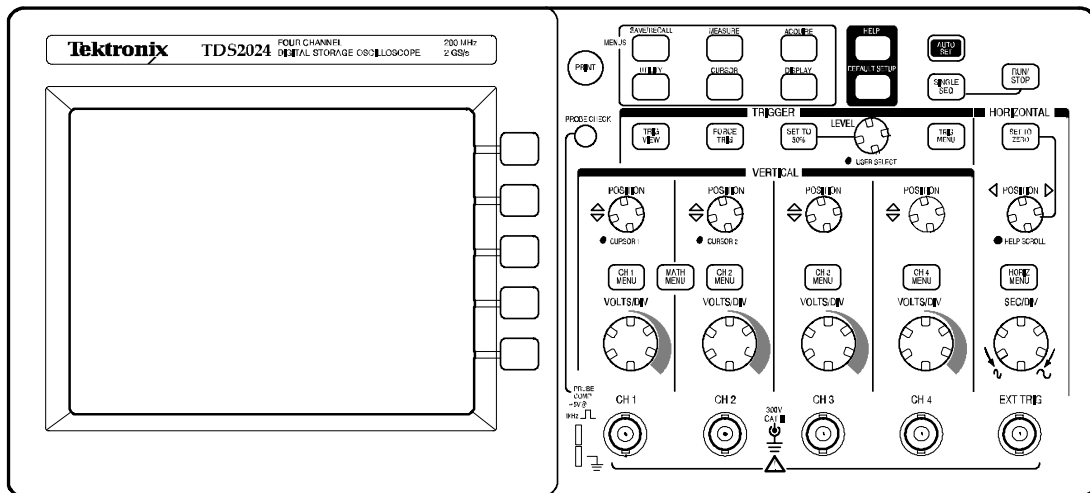

4-channel models



Display Area

In addition to displaying waveforms, the display is filled with many details about the waveform and the oscilloscope control settings.

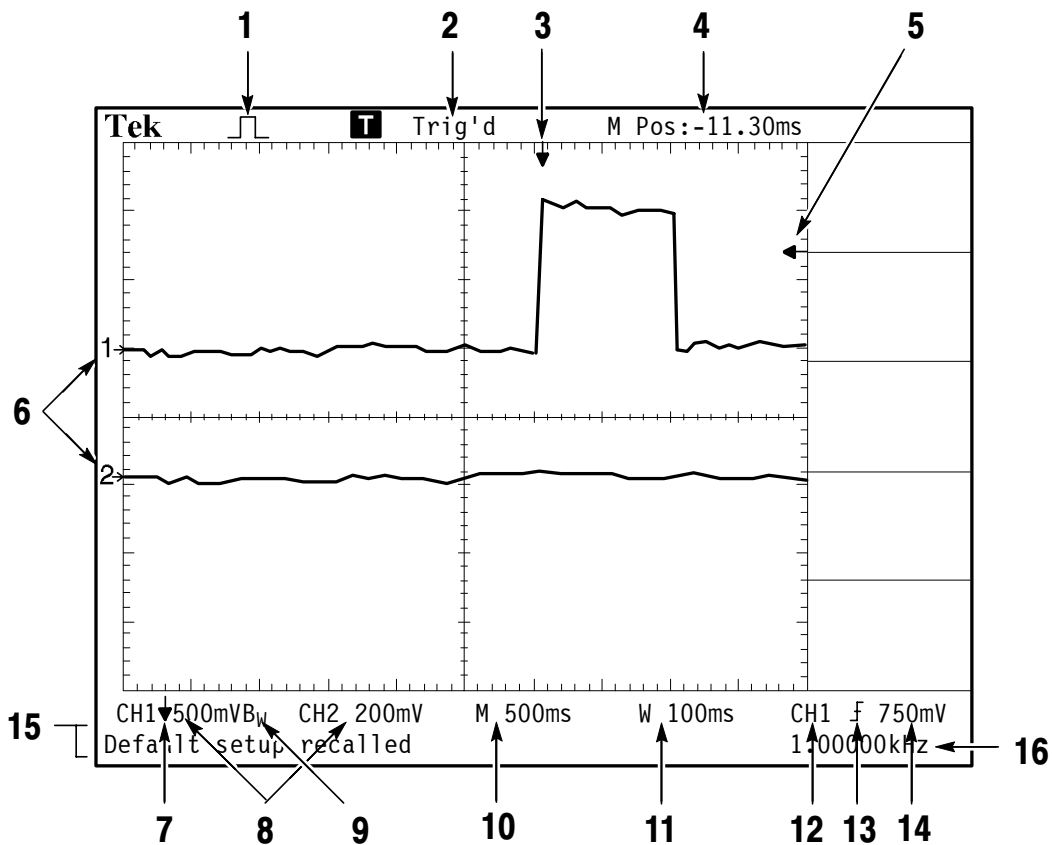





NOTE. For similar details for the FFT function, refer to page 119.



1. Icon display shows acquisition mode.

-  Sample mode
-  Peak detect mode
-  Average mode

2. Trigger status indicates the following:
 - Armed.** The oscilloscope is acquiring pretrigger data. All triggers are ignored in this state.
 - Ready.** All pretrigger data has been acquired and the oscilloscope is ready to accept a trigger.
 - Tri'ed.** The oscilloscope has seen a trigger and is acquiring the posttrigger data.
 - Stop.** The oscilloscope has stopped acquiring waveform data.
 - Acq. Complete.** The oscilloscope has completed a Single Sequence acquisition.
 - Auto.** The oscilloscope is in auto mode and is acquiring waveforms in the absence of triggers.
 - Scan.** The oscilloscope is acquiring and displaying waveform data continuously in scan mode.
3. Marker shows horizontal trigger position. Turn the **HORIZONTAL POSITION** knob to adjust the position of the marker.
4. Readout shows the time at the center graticule. The trigger time is zero.
5. Marker shows Edge or Pulse Width trigger level.
6. On-screen markers show the ground reference points of the displayed waveforms. If there is no marker, the channel is not displayed.

7. An arrow icon indicates that the waveform is inverted.
8. Readouts show the vertical scale factors of the channels.
9. A B_W icon indicates that the channel is bandwidth limited.
10. Readout shows main time base setting.
11. Readout shows window time base setting if it is in use.
12. Readout shows trigger source used for triggering.
13. Icon shows selected trigger type as follows:
 -  - Edge trigger for the rising edge.
 -  - Edge trigger for the falling edge.
 -  - Video trigger for line sync.
 -  - Video trigger for field sync.
 -  - Pulse Width trigger, positive polarity.
 -  - Pulse Width trigger, negative polarity.
14. Readout shows Edge or Pulse Width trigger level.
15. Display area shows helpful messages; some messages display for only three seconds.

If you recall a saved waveform, readout shows information about the reference waveform, such as RefA 1.00V 500 μ s.
16. Readout shows trigger frequency.

Message Area

The oscilloscope displays a message area (item number 15 in the previous figure) at the bottom of the screen that conveys the following types of helpful information:

- Directions to access another menu, such as when you push the TRIG MENU button:
For TRIGGER HOLDOFF, go to HORIZONTAL Menu
- Suggestion of what you might want to do next, such as when you push the MEASURE button:
Push an option button to change its measurement
- Information about the action the oscilloscope performed, such as when you push the DEFAULT SETUP button:
Default setup recalled
- Information about the waveform, such as when you push the AUTOSET button:
Square wave or pulse detected on CH1

Using the Menu System

The user interface of TDS1000- and TDS2000-series oscilloscopes was designed for easy access to specialized functions through the menu structure.

When you push a front-panel button, the oscilloscope displays the corresponding menu on the right side of the screen. The menu shows the options that are available when you push the unlabeled option buttons directly to the right of the screen. (Some documentation may also refer to the option buttons as screen buttons, side-menu buttons, bezel buttons, or soft keys.)

The oscilloscope uses four methods to display menu options:

- **Page (Submenu) Selection:** For some menus, you can use the top option button to choose two or three submenus. Each time you push the top button, the options change. For example, when you push the top button in the SAVE/REC Menu, the oscilloscope cycles through the Setups and Waveforms submenus.
- **Circular List:** The oscilloscope sets the parameter to a different value each time you push the option button. For example, you can push the CH 1 MENU button and then push the top option button to cycle through the Vertical (channel) Coupling options.

- **Action:** The oscilloscope displays the type of action that will immediately occur when you push an Action option button. For example, when you push the DISPLAY Menu button and then push the Contrast Increase option button, the oscilloscope changes the contrast immediately.
- **Radio:** The oscilloscope uses a different button for each option. The currently-selected option is highlighted. For example, the oscilloscope displays various acquisition mode options when you push the ACQUIRE Menu button. To select an option, push the corresponding button.

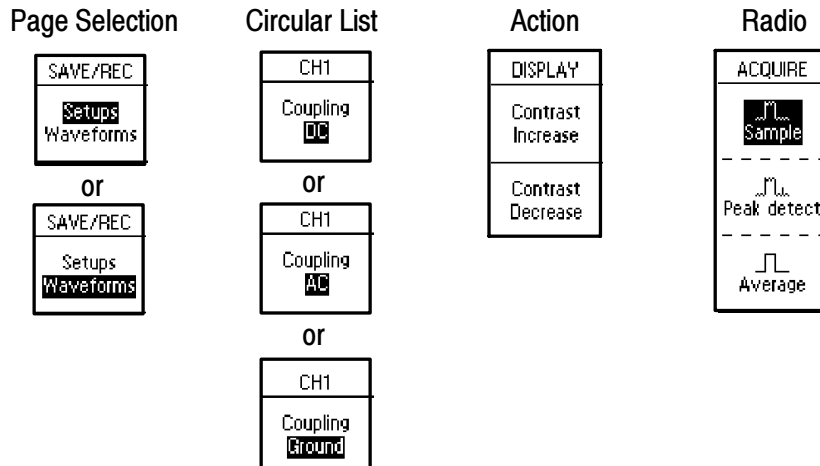

Vertical Controls

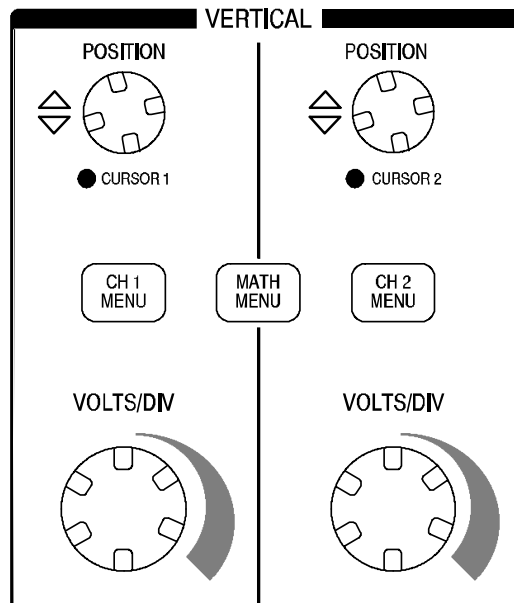

All models

CH 1, CH 2, CH 3, CH 4, CURSOR 1 and CURSOR 2 POSITION. Positions the waveform vertically. When you display and use cursors, an LED lights to indicate the alternative function of the knobs to move the cursors.

CH 1, CH 2, CH 3 & CH 4 MENU. Displays the vertical menu selections and toggles the display of the channel waveform on and off.

VOLTS/DIV (CH 1, CH 2, CH 3 & CH 4). Selects calibrated scale factors.

MATH MENU. Displays waveform math operations menu and can also be used to toggle the math waveform on and off.

Horizontal Controls

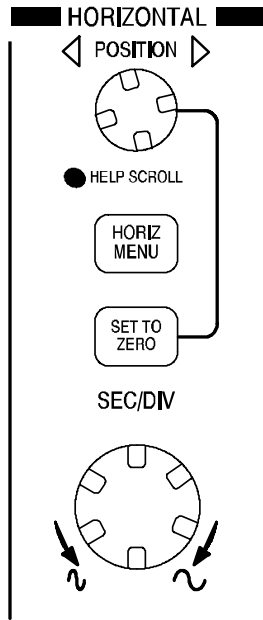

2-channel models

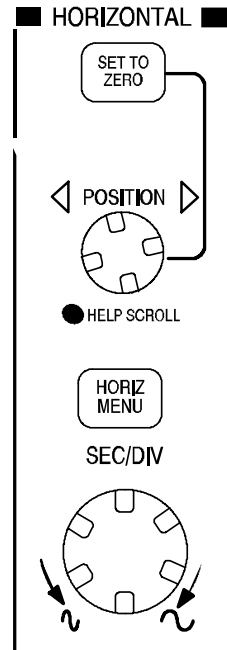

4-channel models

POSITION. Adjusts the horizontal position of all channel and math waveforms. The resolution of this control varies with the time base setting. For information on windows, refer to page 92.

NOTE. To make a large adjustment to the horizontal position, turn the *SEC/DIV* knob to a larger value, change the horizontal position, and then turn the *SEC/DIV* knob back to the previous value.

When you view help topics, you can use this knob to scroll through links or index entries.

HORIZ MENU. Displays the Horizontal Menu.

SET TO ZERO. Sets the horizontal position to zero.

SEC/DIV. Selects the horizontal time/div (scale factor) for the main or the window time base. When Window Zone is enabled, it changes the width of the window zone by changing the window time base. Refer to page 92 for details about creating and using Window Zone.

Trigger Controls

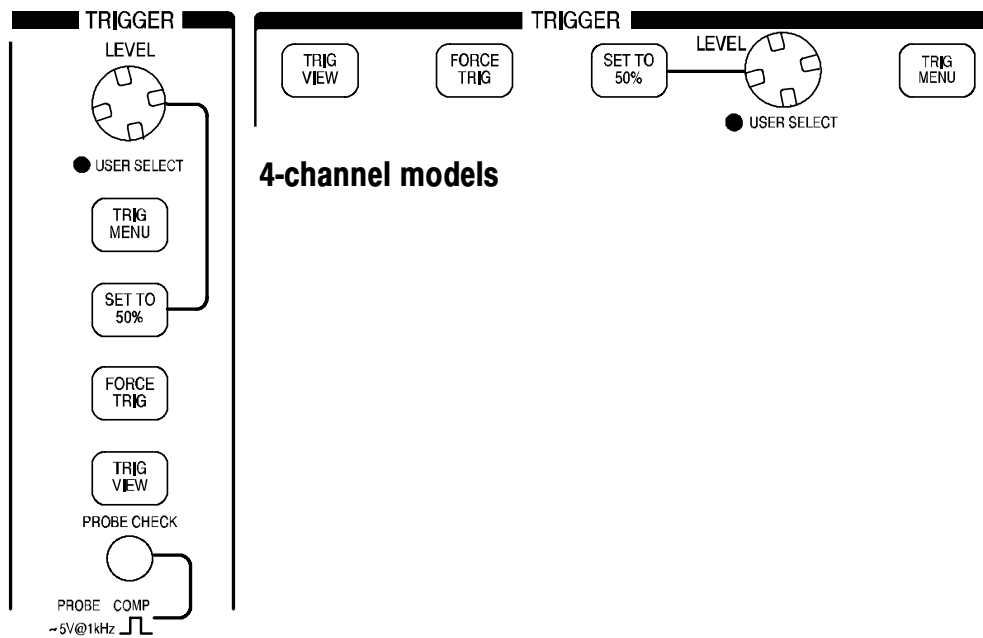

2-channel models

LEVEL and USER SELECT. When you use an Edge trigger, the primary function of the LEVEL knob is to set the amplitude level the signal must cross to cause an acquisition. You can also use the knob to perform USER SELECT alternative functions. The LED lights below the knob to indicate an alternative function.

USER SELECT	Description
Holdoff	Sets the amount of time before another trigger event can be accepted; refer to <i>Holdoff</i> on page 109
Video line number	Sets the oscilloscope to a specific line number when the Trigger Type option is set to Video and the Sync option is set to Line Number
Pulse width	Sets the width of the pulse when the Trigger Type option is set to Pulse and you select the Set Pulse Width option

TRIG MENU. Displays the Trigger Menu.

SET TO 50%. The trigger level is set to the vertical midpoint between the peaks of the trigger signal.

FORCE TRIG. Completes an acquisition regardless of an adequate trigger signal. This button has no effect if the acquisition is already stopped.

TRIG VIEW. Displays the trigger waveform in place of the channel waveform while the TRIG VIEW button is held down. You can use this to see how the trigger settings affect the trigger signal, such as trigger coupling.

Menu and Control Buttons

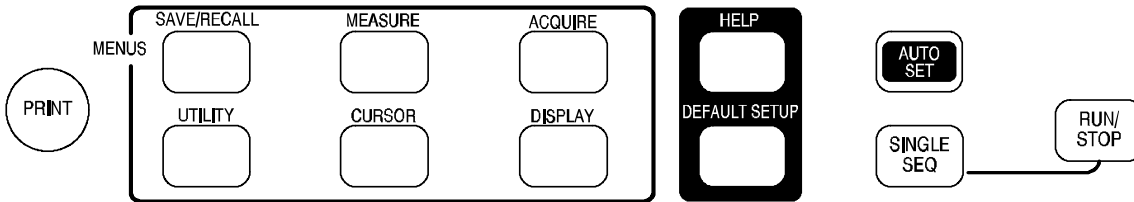

All models

SAVE/RECALL. Displays the Save/Recall Menu for setups and waveforms.

MEASURE. Displays the automated measurements menu.

ACQUIRE. Displays the Acquire Menu.

DISPLAY. Displays the Display Menu.

CURSOR. Displays the Cursor Menu. Vertical Position controls adjust cursor position while displaying the Cursor Menu and the cursors are activated. Cursors remain displayed (unless the Type option is set to Off) after leaving the Cursor Menu but are not adjustable.

UTILITY. Displays the Utility Menu.

HELP. Displays the Help Menu.

DEFAULT SETUP. Recalls the factory setup.

AUTOSET. Automatically sets the oscilloscope controls to produce a usable display of the input signals.

SINGLE SEQ. Acquires a single waveform and then stops.

RUN/STOP. Continuously acquires waveforms or stops the acquisition.

PRINT. Starts print operations. An extension module with a Centronics, RS-232, or GPIB port is required. Refer to *Optional Accessories* on page 169.

Connectors

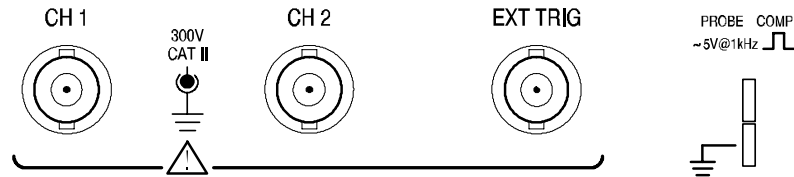

2-channel models

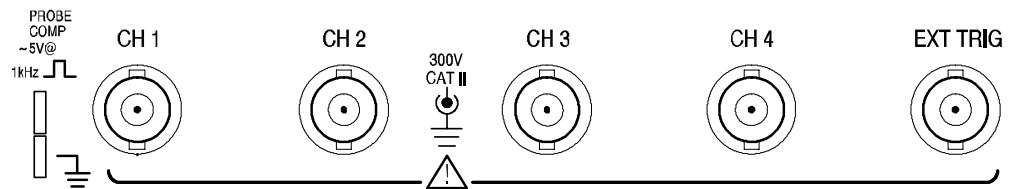

4-channel models

PROBE COMP. Voltage probe compensation output and ground. Use to electrically match the probe to the oscilloscope input circuit. Refer to page 8. The probe compensation ground and BNC shields connect to earth ground and are considered to be ground terminals



CAUTION. *If you connect a voltage source to a ground terminal, you may damage the oscilloscope or the circuit under test. To avoid this, do not connect a voltage source to any ground terminals.*

CH 1, CH 2, CH 3 & CH 4. Input connectors for waveform display.

EXT TRIG. Input connector for an external trigger source. Use the Trigger Menu to select the Ext or Ext/5 trigger source.

Application Examples

This section presents a series of application examples. These simplified examples highlight the features of the oscilloscope and give you ideas for using it to solve your own test problems.

- Taking simple measurements
 - Using Autoset
 - Using the Measure Menu to take automatic measurements
 - Measuring two signals and calculating gain
- Taking cursor measurements
 - Measuring ring frequency and ring amplitude
 - Measuring pulse width
 - Measuring rise time
- Analyzing signal detail
 - Looking at a noisy signal
 - Using the average function to separate a signal from noise
- Capturing a single-shot signal
 - Optimizing the acquisition
- Measuring propagation delay
- Triggering on a pulse width
- Triggering on a video signal
 - Triggering on video fields and video lines
 - Using the window function to see waveform details
- Analyzing a differential communication signal using math functions
- Viewing impedance changes in a network using XY mode and persistence

Taking Simple Measurements

You need to see a signal in a circuit, but you do not know the amplitude or frequency of the signal. You want to quickly display the signal and measure the frequency, period, and peak-to-peak amplitude.

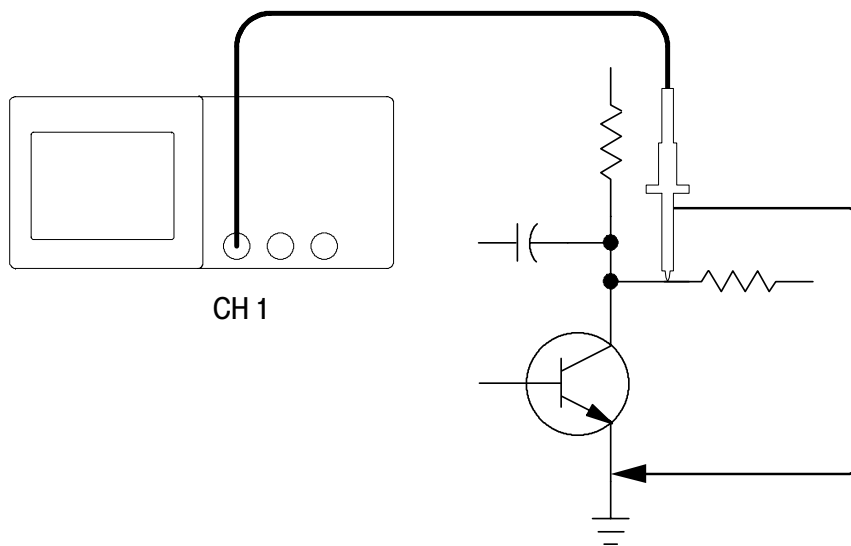

Using Autoset

To quickly display a signal, follow these steps:

1. Push the **CH 1 MENU** button and set the **Probe** option attenuation to **10X**.
2. Set the switch to **10X** on the P2200 probe.

3. Connect the channel 1 probe to the signal.
4. Push the **AUTOSET** button.

The oscilloscope sets the vertical, horizontal, and trigger controls automatically. If you want to optimize the display of the waveform, you can manually adjust these controls.

NOTE. *The oscilloscope displays relevant automatic measurements in the waveform area of the screen based on the signal type detected.*

For oscilloscope-specific descriptions, refer to page 79 in the *Reference* chapter.

Taking Automatic Measurements

The oscilloscope can take automatic measurements of most displayed signals. To measure signal frequency, period, and peak-to-peak amplitude, rise time, and positive width, follow these steps:

1. Push the **MEASURE** button to see the Measure Menu.
2. Push the top option button; the Measure 1 Menu appears.

3. Push the **Type** option button and select **Freq.**

The **Value** readout displays the measurement and updates.

NOTE. *If a question mark (?) displays in the Value readout, turn the VOLTS/DIV knob for the appropriate channel to increase the sensitivity or change the SEC/DIV setting.*

4. Push the **Back** option button.
5. Push the second option button from the top; the Measure 2 Menu appears.
6. Push the **Type** option button and select **Period.**
The **Value** readout displays the measurement and updates.
7. Push the **Back** option button.
8. Push the middle option button; the Measure 3 Menu appears.
9. Push the **Type** option button and select **Pk-Pk.**
The **Value** readout displays the measurement and updates.
10. Push the **Back** option button.

11. Push the second option button from the bottom; the Measure 4 Menu appears.
12. Push the **Type** option button and select **Rise Time**.
The **Value** readout displays the measurement and updates.
13. Push the **Back** option button.
14. Push the bottom option button; the Measure 5 Menu appears.
15. Push the **Type** option button and select **Pos Width**.
The **Value** readout displays the measurement and updates.
16. Push the **Back** option button.

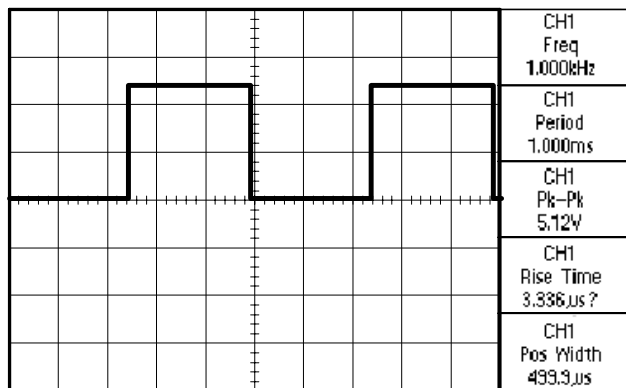

Measuring Two Signals

You are testing a piece of equipment and need to measure the gain of the audio amplifier. You have an audio generator that can inject a test signal at the amplifier input. Connect two oscilloscope channels to the amplifier input and output as shown. Measure both signal levels and use the measurements to calculate the gain.

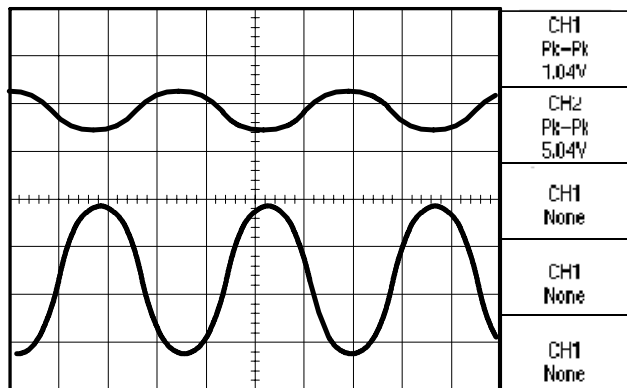
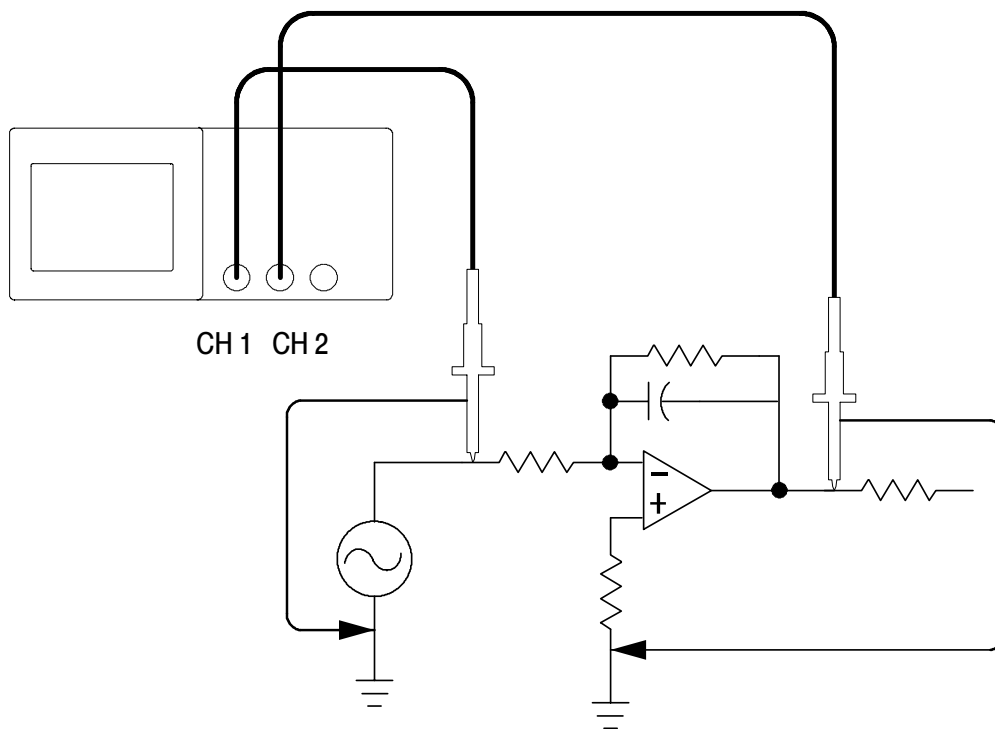

To activate and display the signals connected to channel 1 and to channel 2, follow these steps:

1. If the channels are not displayed, push the **CH 1 MENU** and **CH 2 MENU** buttons.
2. Push the **AUTOSET** button.

To select measurements for the two channels, follow these steps:

1. Push the **Measure** button to see the Measure Menu.
2. Push the top option button; the Measure 1 Menu appears.
3. Push the **Source** option button and select **CH1**.
4. Push the **Type** option button and select **Pk-Pk**.
5. Push the **Back** option button.
6. Push the second option button from the top; the Measure 2 Menu appears.
7. Push the **Source** option button and select **CH2**.
8. Push the **Type** option button and select **Pk-Pk**.
9. Push the **Back** option button.

Read the displayed peak-to-peak amplitudes for both channels.

10. To calculate the amplifier voltage gain, use these equations:

$$\text{VoltageGain} = \frac{\text{output amplitude}}{\text{input amplitude}}$$

$$\text{VoltageGain (dB)} = 20 \times \log_{10}(\text{VoltageGain})$$

Taking Cursor Measurements

You can use the cursors to quickly take time and voltage measurements on a waveform.

Measuring Ring Frequency

To measure the ring frequency at the rising edge of a signal, follow these steps:

1. Push the **CURSOR** button to see the Cursor Menu.
2. Push the **Type** option button and select **Time**.
3. Push the **Source** option button and select **CH1**.
4. Turn the **CURSOR 1** knob to place a cursor on the first peak of the ring.
5. Turn the **CURSOR 2** knob to place a cursor on the second peak of the ring.

You can see the delta time and frequency (the measured ring frequency) in the Cursor Menu.

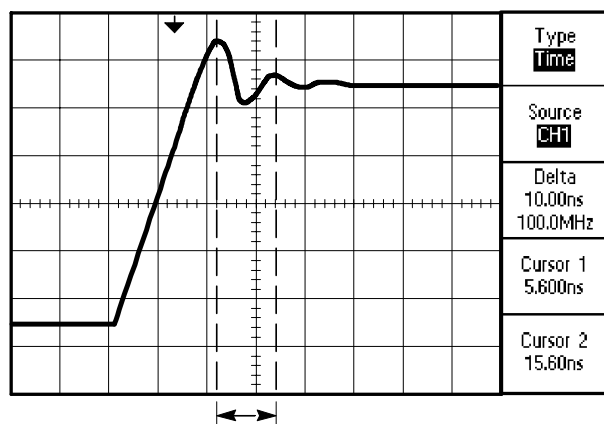

Measuring Ring Amplitude

You measured the ring frequency in the previous example. Now you want to measure the amplitude of the ringing. To measure the amplitude, follow these steps:

1. Push the **CURSOR** button to see the Cursor Menu.
2. Push the **Type** option button and select **Voltage**.
3. Push the **Source** option button and select **CH1**.
4. Turn the **CURSOR 1** knob to place a cursor on the highest peak of the ring.
5. Turn the **CURSOR 2** knob to place a cursor on the lowest point of the ring.

You can see the following measurements in the Cursor Menu:

- The delta voltage (peak-to-peak voltage of the ringing)
- The voltage at Cursor 1
- The voltage at Cursor 2

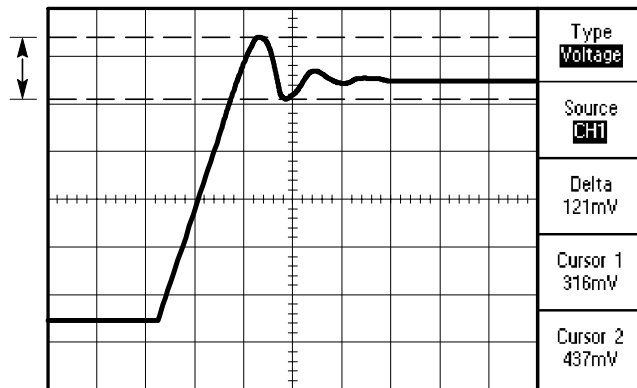

Measuring Pulse Width

You are analyzing a pulse waveform, and you want to know the width of the pulse. To measure the width of a pulse using the time cursors, follow these steps:

1. Push the **CURSOR** button to see the Cursor Menu.
LEDs light under the **VERTICAL POSITION** knobs to indicate the alternative **CURSOR1** and **CURSOR2** functions.
2. Push the **Source** option button and select **CH1**.
3. Push the **Type** option button and select **Time**.
4. Turn the **CURSOR 1** knob to place a cursor on the rising edge of the pulse.
5. Turn the **CURSOR 2** knob to place the remaining cursor on the falling edge of the pulse.

You can see the following measurements in the Cursor Menu:

- The time at Cursor 1, relative to the trigger.
- The time at Cursor 2, relative to the trigger.
- The delta time, which is the pulse width measurement.

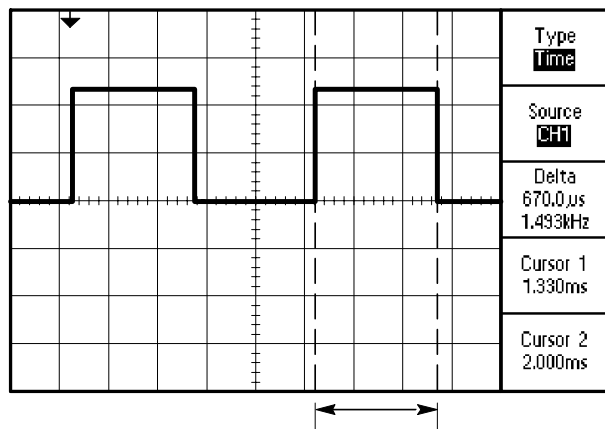

NOTE. *The Positive Width measurement is available as an automatic measurement in the Measure Menu, described on page 94.*

The Positive Width measurement also displays when you select the Single-Cycle Square option in the AUTOSET Menu. Refer to page 82.

Measuring Rise Time

After measuring the pulse width, you decide that you need to check the rise time of the pulse. Typically, you measure rise time between the 10% and 90% levels of the waveform. To measure the rise time, follow these steps:

1. Turn the **SEC/DIV** knob to display the rising edge of the waveform.

2. Turn the **VOLTS/DIV** and **VERTICAL POSITION** knobs to set the waveform amplitude to about five divisions.
3. Push the **CH 1 MENU** button to see the CH1 Menu if it is not displayed.
4. Push the **Volts/Div** option button and select **Fine**.
5. Turn the **VOLTS/DIV** knob to set the waveform amplitude to exactly five divisions.
6. Turn the **VERTICAL POSITION** knob to center the waveform; position the baseline of the waveform 2.5 divisions below the center graticule.
7. Push the **CURSOR** button to see the Cursor Menu.
8. Push the **Type** option button and select **Time**.
9. Turn the **CURSOR 1** knob to place the cursor at the point where the waveform crosses the second graticule line below center screen. This is the 10% level of the waveform.

- 10.** Turn the **CURSOR 2** knob to place the second cursor at the point where the waveform crosses the second graticule line above center screen. This is the 90% level of the waveform.
- 11.** The **Delta** readout in the Cursor Menu is the rise time of the waveform.

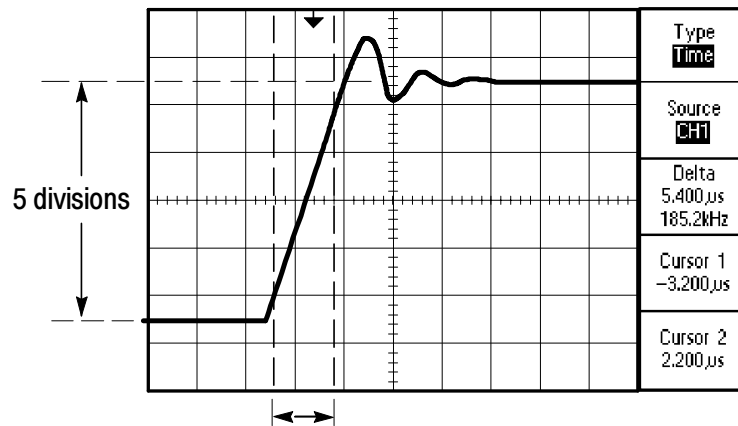

NOTE. The Rise Time measurement is available as an automatic measurement in the Measure Menu, described on page 94.

The Rise Time measurement also displays when you select the Rising Edge option in the AUTOSET Menu. Refer to page 82.

Analyzing Signal Detail

You have a noisy signal displayed on the oscilloscope and you need to know more about it. You suspect that the signal contains much more detail than you can now see in the display.

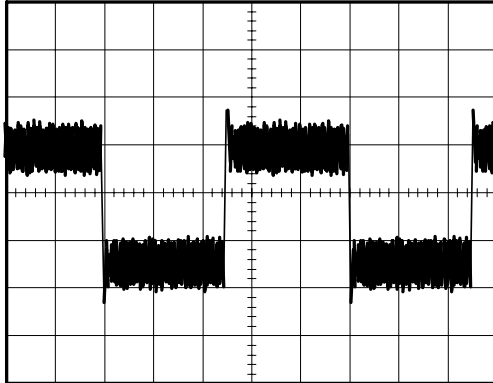

Looking at a Noisy Signal

The signal appears noisy and you suspect that noise is causing problems in your circuit. To better analyze the noise, follow these steps:

1. Push the **ACQUIRE** button to see the Acquire Menu.
2. Push the **Peak Detect** option button.
3. If necessary, push the **DISPLAY** button to see the Display Menu. Use the **Contrast Increase** and **Contrast Decrease** option buttons to adjust the contrast to see the noise more easily.

Peak detect emphasizes noise spikes and glitches in your signal, especially when the time base is set to a slow setting.

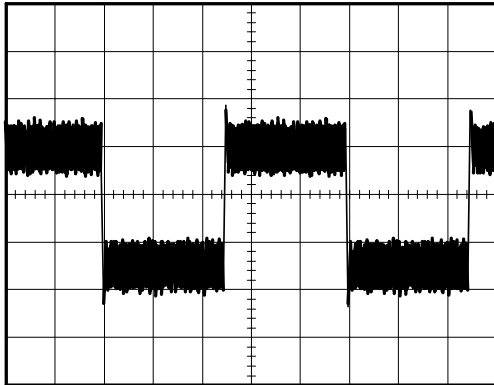

Separating the Signal from Noise

Now you want to analyze the signal shape and ignore the noise. To reduce random noise in the oscilloscope display, follow these steps:

1. Push the **ACQUIRE** button to see the Acquire Menu.
2. Push the **Average** option button.
3. Push the **Averages** option button to see the effects of varying the number of running averages on the waveform display.

Averaging reduces random noise and makes it easier to see detail in a signal. In the example below, a ring shows on the rising and falling edges of the signal when the noise is removed.

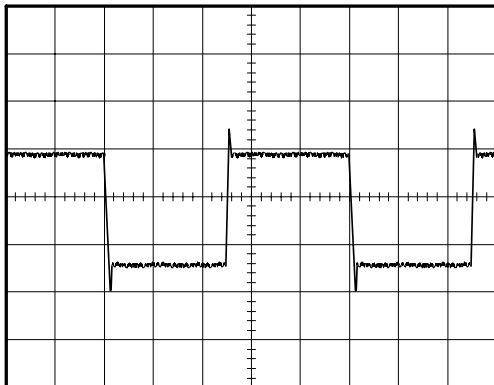

Capturing a Single-Shot Signal

The reliability of a reed relay in a piece of equipment has been poor and you need to investigate the problem. You suspect that the relay contacts arc when the relay opens. The fastest you can open and close the relay is about once per minute so you need to capture the voltage across the relay as a single-shot acquisition.

To set up for a single-shot acquisition, follow these steps:

1. Turn the vertical **VOLTS/DIV** and horizontal **SEC/DIV** knobs to the appropriate ranges for the signal you expect to see.
2. Push the **ACQUIRE** button to see the Acquire Menu.
3. Push the **Peak Detect** option button.
4. Push the **TRIG MENU** button to see the Trigger Menu.
5. Push the **Slope** option button and select **Rising**.
6. Turn the **LEVEL** knob to adjust the trigger level to a voltage midway between the open and closed voltages of the relay.
7. Push the **SINGLE SEQ** button to start the acquisition.

When the relay opens, the oscilloscope triggers and captures the event.

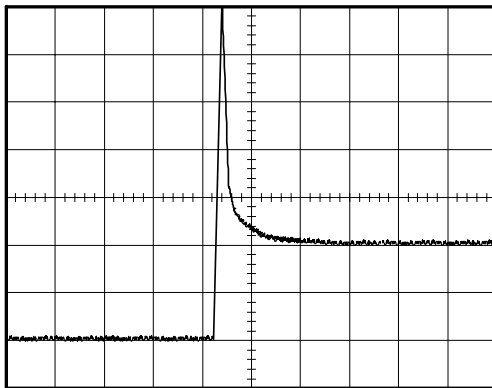

Optimizing the Acquisition

The initial acquisition shows the relay contact beginning to open at the trigger point. This is followed by a large spike that indicates contact bounce and inductance in the circuit. The inductance can cause contact arcing and premature relay failure.

You can use the vertical, horizontal, and trigger controls to optimize the settings before the next single-shot event is captured.

When the next acquisition is captured with the new settings (when you push the **SINGLE SEQ** button again), you can see more detail about the relay contact opening. You can now see that the contact bounces several times as it opens.

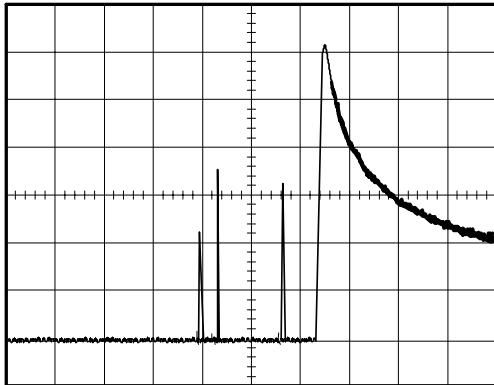

Measuring Propagation Delay

You suspect that the memory timing in a microprocessor circuit is marginal. Set up the oscilloscope to measure the propagation delay between the chip-select signal and the data output of the memory device.

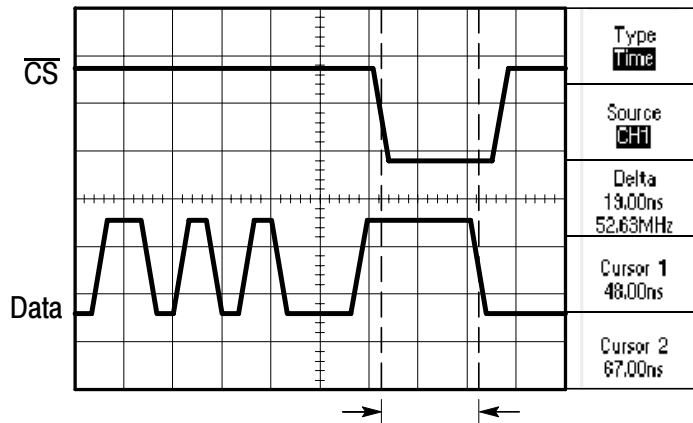
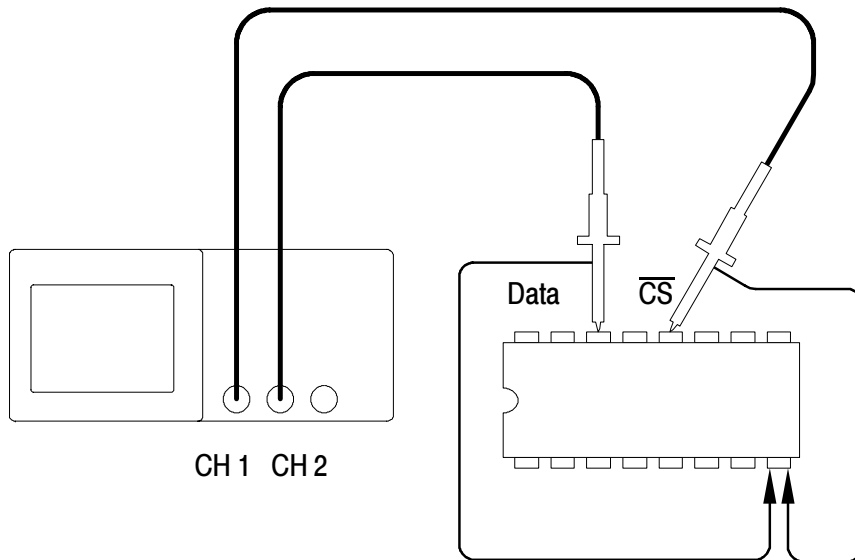

To set up to measure propagation delay, follow these steps:

1. If the channels are not displayed, push the **CH 1 MENU** and then **CH 2 MENU** buttons.
2. Push the **AUTOSET** button to trigger a stable display.
3. Adjust the horizontal and vertical controls to optimize the display.
4. Push the **CURSOR** button to see the Cursor Menu.
5. Push the **Type** option button and select **Time**.
6. Push the **Source** option button and select **CH1**.
7. Turn the **CURSOR 1** knob to place the cursor on the active edge of the chip-select signal.
8. Turn the **CURSOR 2** knob to place the second cursor on the data output transition.
9. Read the propagation delay in the **Delta** readout in the Cursor Menu.

Triggering on a Specific Pulse Width

You are testing the pulse widths of a signal in a circuit. It is critical that the pulses all be a specific width and you need to verify that they are. Edge triggering shows that your signal is as specified, and the pulse width measurement does not vary from the specification. However, you think there might be a problem.

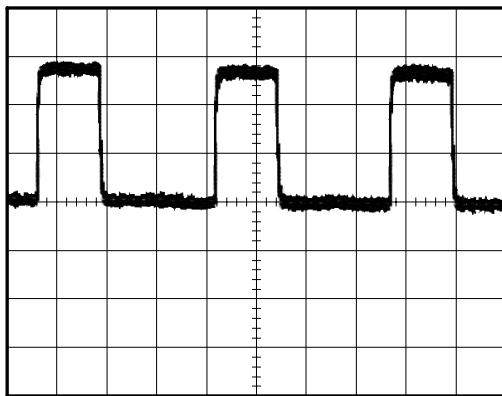

To set up a test for pulse width aberrations, follow these steps:

1. Display the suspect signal on Ch 1. If Ch1 is not displayed, push the **CH1 MENU** button.
2. Push the **AUTOSET** button to trigger a stable display.
3. Push the **Single Cycle** option button in the **AUTOSET** Menu to view a single cycle of the signal, and to quickly take a **Pulse Width** measurement.
4. Push the **TRIG MENU** button.
5. Push the **Type** option button to select **Pulse**.

6. Push the **Source** option button to select **CH1**.
7. Turn the **TRIGGER LEVEL** knob to set the trigger level near the bottom of the signal.
8. Push the **When** option button to select = (equal).
9. Push the **Set Pulse Width** option button, and turn the **USER SELECT** knob to set the pulse width to the value reported by the Pulse Width measurement in step 3.
10. Push - more- page 1 of 2 and set the **Mode** option to **Normal**.

You should achieve a stable display with the oscilloscope triggering on normal pulses.

11. Push the **When** option button to select \neq , $<$, or $>$. If there are any aberrant pulses that meet the specified **When** condition, the oscilloscope triggers.

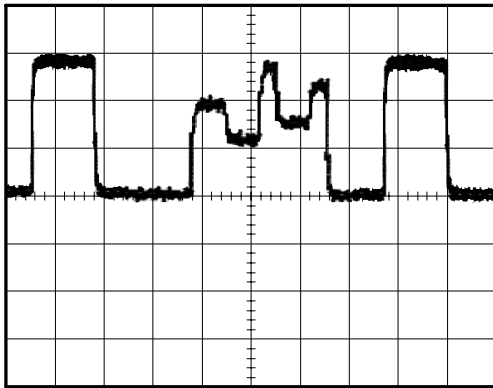

NOTE. *The trigger frequency readout shows the frequency of events the oscilloscope considers to be triggers, and may be less than the frequency of the input signal in Pulse Width trigger mode.*

Triggering on a Video Signal

You are testing the video circuit in a piece of medical equipment and need to display the video output signal. The video output is an NTSC standard signal. Use the video trigger to obtain a stable display.

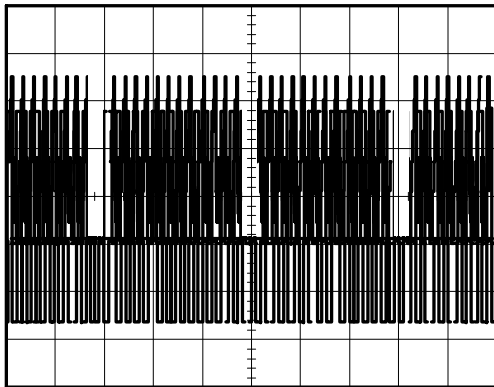
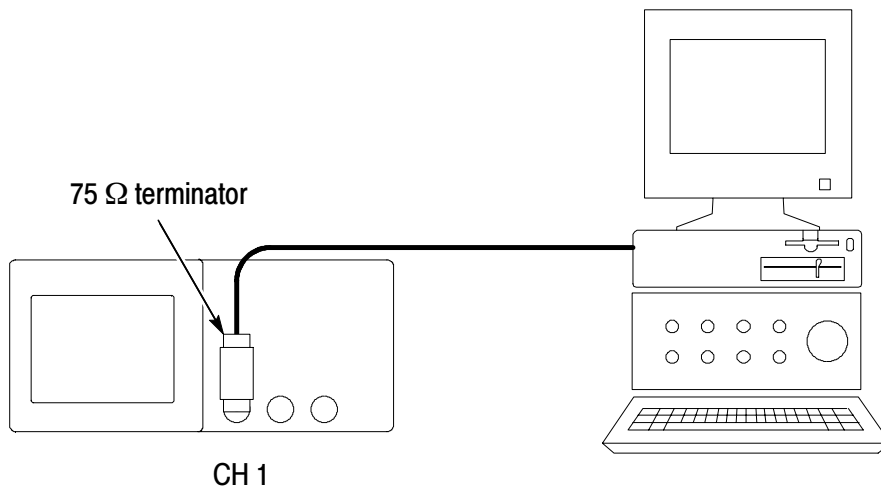

NOTE. *Most video systems use 75 ohm cabling. The oscilloscope inputs do not properly terminate low impedance cabling. To avoid amplitude inaccuracy from improper loading and reflections, place a 75 ohm feedthrough terminator (Tektronix part number 011-0055-02 or equivalent) between the 75 ohm coaxial cable from the signal source and the oscilloscope BNC input.*

Triggering on Video Fields

Automatic. To trigger on the video fields, follow these steps:

1. Push the **AUTOSET** button. When Autoset is complete, the oscilloscope displays the video signal with sync on **All Fields**.
2. Push the **Odd Field** or **Even Field** option buttons from the **AUTOSET** Menu to sync on odd or even fields only.

Manual. An alternative method requires more steps, but may be necessary depending on the video signal. To use the method, follow these steps:

1. Push the **TRIG MENU** button to see the Trigger Menu.
2. Push the top option button and select **Video**.
3. Push the **Source** option button and select **CH1**.
4. Push the **Sync** option button and select **All Fields**, **Odd Field**, or **Even Field**.
5. Push the **Standard** option button and select **NTSC**.
6. Turn the horizontal **SEC/DIV** knob to see a complete field across the screen.
7. Turn the vertical **VOLTS/DIV** knob to ensure that the entire video signal is visible on the screen.

Triggering on Video Lines

Automatic. You can also look at the video lines in the field. To trigger on the video lines, follow these steps:

1. Push the **AUTOSET** button.
2. Push the top option button to select **Line** to sync on all lines. (The **AUTOSET** Menu includes **All Lines** and **Line Number** options.)

Manual. An alternative method requires more steps, but may be necessary depending on the video signal. To use the method, follow these steps:

1. Push the **TRIG MENU** button to see the Trigger Menu.
2. Push the top option button and select **Video**.
3. Push the **Sync** option button and select **All Lines**. or **Line Number** and turn the **USER SELECT** knob to set a specific line number.
4. Push the **Standard** option button and select **NTSC**.
5. Turn the **SEC/DIV** knob to see a complete video line across the screen.
6. Turn the **VOLTS/DIV** knob to ensure that the entire video signal is visible on the screen.

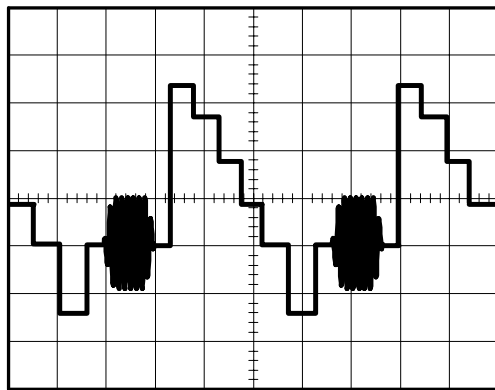
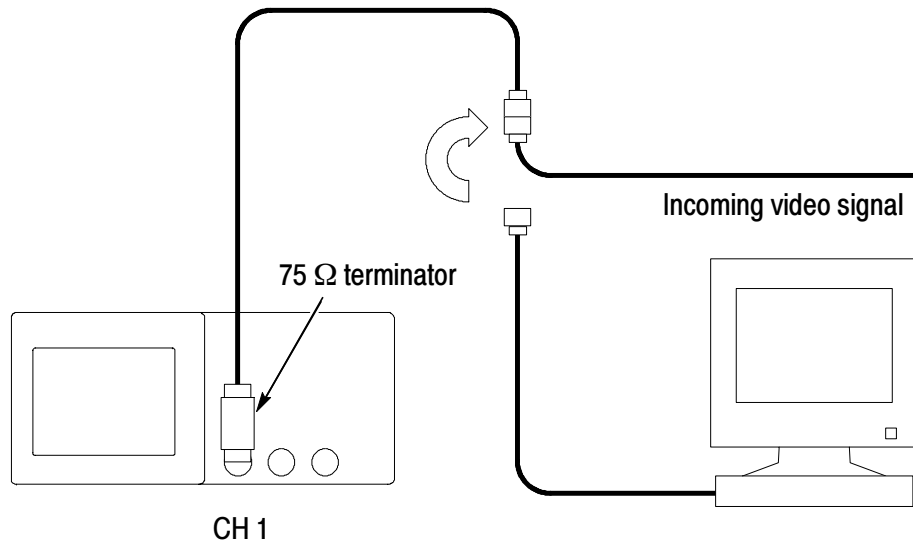

Using the Window Function to See Waveform Details

You can use the window function to examine a specific portion of a waveform without changing the main display.

If you want to view the color burst in the previous waveform in more detail without changing the main display, follow these steps:

1. Push the **HORIZ MENU** button to see the Horizontal Menu and select the **Main** option.
2. Push the **Window Zone** option button.
3. Turn the **SEC/DIV** knob and select 500 ns. This will be the **SEC/DIV** setting of the expanded view.
4. Turn the **HORIZONTAL POSITION** knob to position the window around the portion of the waveform that you want to expand.

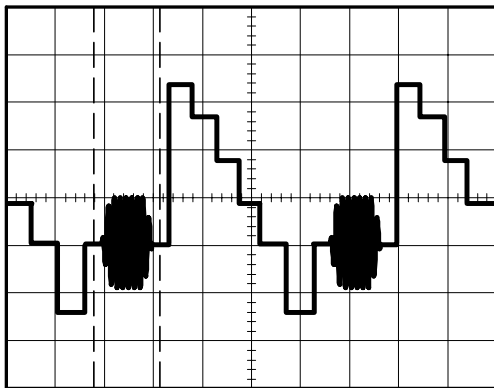

5. Push the **Window** option button to see the expanded portion of the waveform.
6. Turn the **SEC/DIV** knob to optimize viewing the expanded waveform.

To switch between the Main and Window views, push the **Main** or **Window** option button in the Horizontal Menu.

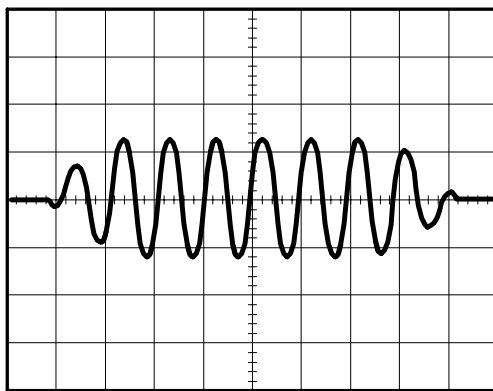

Analyzing a Differential Communication Signal

You are having intermittent problems with a serial data communication link, and you suspect poor signal quality. Set up the oscilloscope to show you a snapshot of the serial data stream so you can verify the signal levels and transition times.

Because this is a differential signal, you use the math function of the oscilloscope to view a better representation of the waveform.

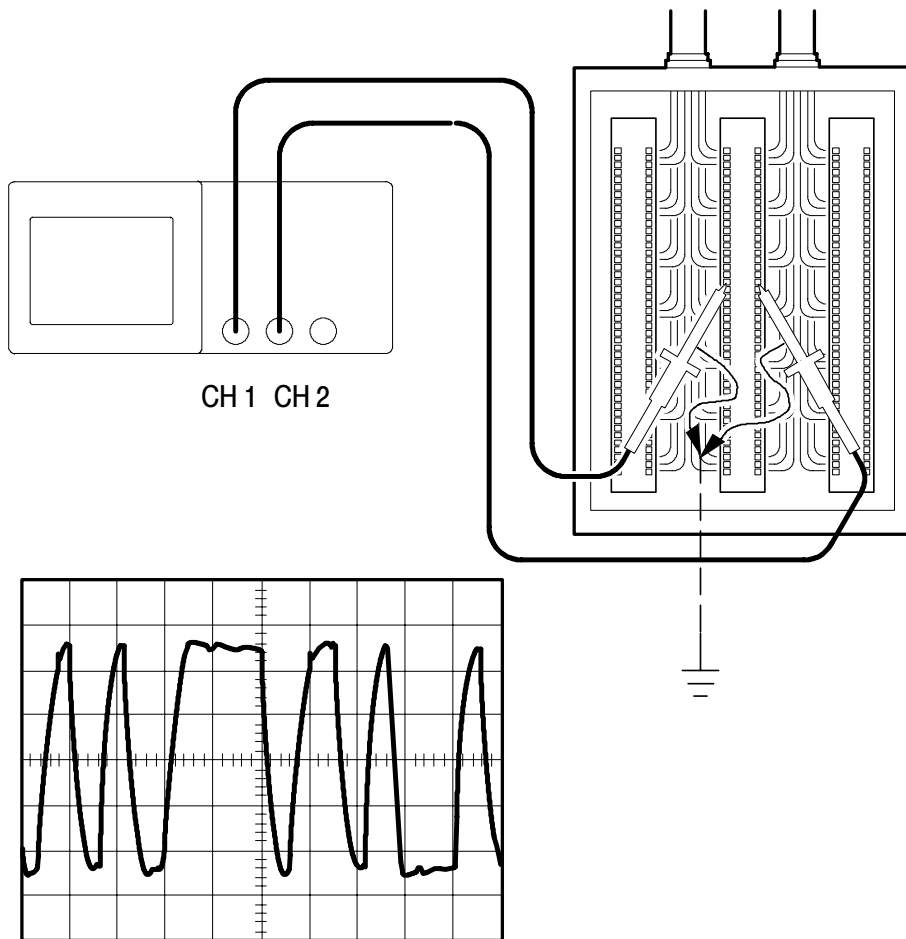

NOTE. *Be sure to first compensate both probes. Differences in probe compensation appear as errors in the differential signal.*

To activate the differential signals connected to channel 1 and channel 2, follow these steps:

1. Push the **CH 1 MENU** button and set the Probe option attenuation to 10X.
2. Push the **CH 2 MENU** button and set the Probe option attenuation to 10X.
3. Set the switches to 10X on the P2200 probes.
4. Push the **AUTOSET** button.
5. Push the **MATH MENU** button to see the Math Menu.
6. Push the **Operation** option button and select **-**.
7. Push the **CH1-CH2** option button to display a new waveform that is the difference between the displayed waveforms.
8. You can adjust the vertical scale and position of the Math waveform. To do so, follow these steps:
 - a. Remove the channel 1 and channel 2 waveforms from the display.
 - b. Turn the CH 1 and CH 2 VOLTS/DIV and VERTICAL POSITION knobs to adjust the vertical scale and position.

For a more stable display, push the **SINGLE SEQ** button to control the acquisition of the waveform. Each time you push the **SINGLE SEQ** button, the oscilloscope acquires a snapshot of the digital data stream. You can use the cursors or automatic measurements to analyze the waveform, or you can store the waveform to analyze later.

NOTE. *Vertical sensitivity should match on waveforms used for math operations. If they do not match, and you use cursors to measure the waveform result, a U displays that represents unknown in the level and delta readouts.*

Viewing Impedance Changes in a Network

You have designed a circuit that needs to operate over a wide temperature range. You need to evaluate the change in impedance of the circuit as the ambient temperature is changed.

Connect the oscilloscope to monitor the input and output of the circuit and capture the changes that occur as you vary the temperature.

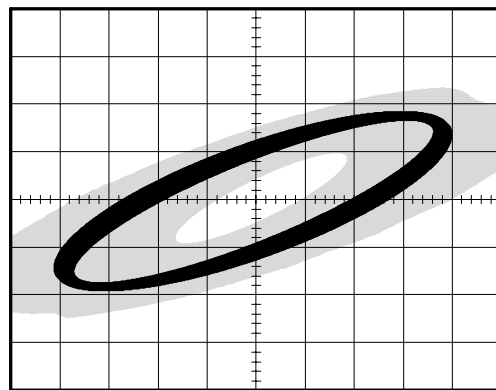
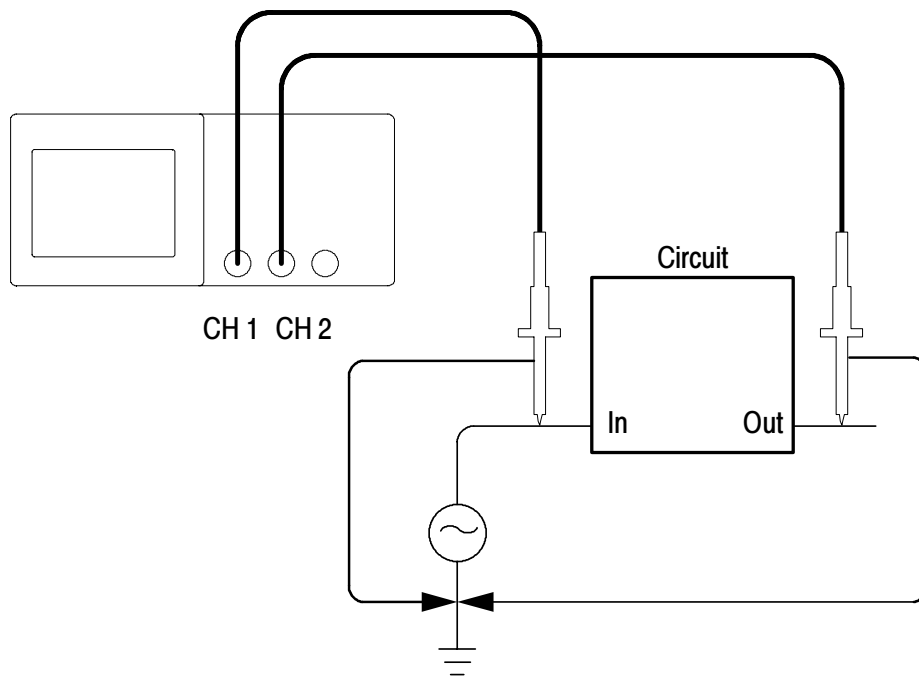

To view the input and output of the circuit in an XY display, follow these steps:

1. Push the **CH 1 MENU** button and set the **Probe** option attenuation to **10X**.
2. Push the **CH 2 MENU** button and set the **Probe** option attenuation to **10X**.
3. Set the switches to **10X** on the P2200 probes.
4. Connect the channel 1 probe to the input of the network, and connect the channel 2 probe to the output.
5. Push the **AUTOSET** button.
6. Turn the **VOLTS/DIV** knobs to display approximately the same amplitude signals on each channel.
7. Push the **DISPLAY** button.
8. Push the **Format** option button and select **XY**.

The oscilloscope displays a Lissajous pattern representing the input and output characteristics of the circuit.

9. Turn the **VOLTS/DIV** and **VERTICAL POSITION** knobs to optimize the display.
10. Push the **Persist** option button and select **Infinite**.
11. Push the **Contrast Increase** or **Contrast Decrease** option buttons to adjust the contrast of the screen.

As you adjust the ambient temperature, the display persistence captures the changes in the characteristics of the circuit.

Reference

This chapter describes the menus and operating details associated with each front-panel menu button or control.

Topic	Page
Acquire: menu, RUN/STOP button and SINGLE SEQ button	74
Autoset	79
Cursors	84
Default setup	85
Display	86
Help	89
Horizontal controls: menu, SET TO ZERO button, HORIZONTAL POSITION knob and SEC/DIV knob	90
Math	93
Measure	94
Print	96
Probe check	96
Save/Recall	97
Trigger controls: menu, SET TO 50% button, FORCE TRIG button, TRIG VIEW button and LEVEL (or USER SELECT) knob	99
Utility	110
Vertical controls: menu, VERTICAL POSITION knobs and VOLTS/DIV knobs	112

Acquire

Push the ACQUIRE button to set acquisition parameters.

Options	Settings	Comments
Sample		Use to acquire and accurately display most waveforms; this is the default mode
Peak Detect		Use to detect glitches and reduce the possibility of aliasing
Average		Use to reduce random or uncorrelated noise in the signal display; the number of averages is selectable
Averages	4 16 64 128	Select number of averages

Key Points

If you probe a noisy square wave signal that contains intermittent, narrow glitches, the waveform displayed will vary depending on the acquisition mode you choose.

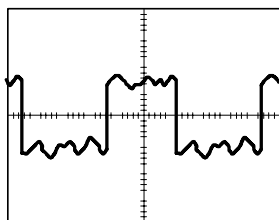

Sample

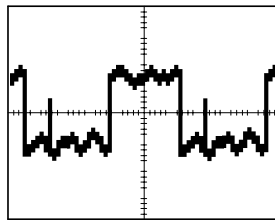

Peak Detect

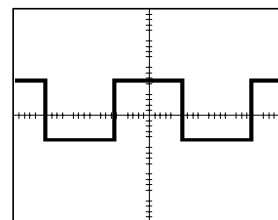

Average

Sample. Use Sample acquisition mode to acquire 2500 points and display them at the SEC/DIV setting. Sample mode is the default mode.

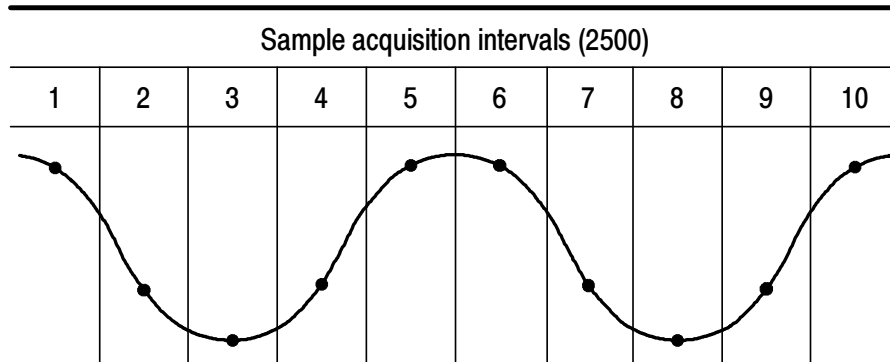

- Sample points

Sample mode acquires a single sample point in each interval.

The maximum sample rate is 1 GS/s for oscilloscope models with a bandwidth of 60 MHz or 100 MHz and 2 GS/s for the 200 MHz models. At 100 ns and faster settings, this sample rate does not acquire 2500 points. In this case, a Digital Signal Processor interpolates points between the sampled points to make a full 2500 point waveform record.

Peak Detect. Use Peak Detect acquisition mode to detect glitches as narrow as 10 ns and to limit the possibility of aliasing. This mode is effective when at the SEC/DIV setting of 5 $\mu\text{s}/\text{div}$ or slower.

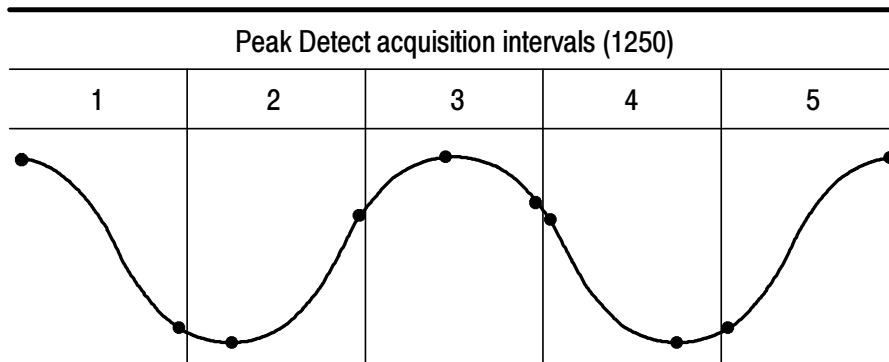

- Sample points displayed

Peak Detect mode displays the highest and lowest acquired voltage in each interval.

NOTE. If you set the SEC/DIV setting to 2.5 $\mu\text{s}/\text{div}$ or faster, the acquisition mode changes to Sample because the sample rate is fast enough that Peak Detect is not necessary. The oscilloscope does not display a message to tell you that the mode was changed to Sample.

When there is enough waveform noise, a typical peak detect display shows large black areas. The TDS1000- and TDS2000-series oscilloscopes display this area with diagonal lines to improve display performance.



Typical peak detect display

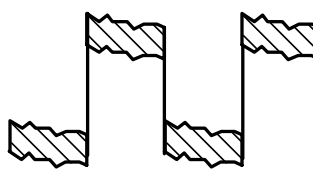

TDS1000/TDS2000 peak detect display

Average. Use Average acquisition mode to reduce random or uncorrelated noise in the signal you want to display. Data is acquired in sample mode, then a number of waveforms are averaged together.

Select the number of acquisitions (4, 16, 64, or 128) to average for the waveform.

RUN/STOP Button. Push the RUN/STOP button when you want the oscilloscope to continuously acquire waveforms. Push the button again to stop the acquisition.

SINGLE SEQ Button. Push the SINGLE SEQ button when you want the oscilloscope to acquire a single waveform and then stop. Each time you push the SINGLE SEQ button, the oscilloscope begins to acquire another waveform. After the oscilloscope detects a trigger it completes the acquisition and stops.

Acquisition mode	SINGLE SEQ button
Sample, Peak Detect	Sequence is complete when one acquisition is acquired
Average	Sequence is complete when the defined number of acquisitions is reached (refer to page 74)

Scan Mode Display. You can use the Horizontal Scan acquisition mode (also called Roll mode) to continuously monitor signals that change slowly. The oscilloscope displays waveform updates from the left to the right of the screen and erases old points as it displays new points. A moving, one-division-wide blank section of the screen separates the new waveform points from the old.

The oscilloscope changes to the Scan acquisition mode when you turn the SEC/DIV knob to 100 ms/div or slower, and select the Auto Mode option in the TRIGGER Menu.

To disable Scan mode, push the TRIG MENU button and set the Mode option to Normal.

Stopping the Acquisition. While the acquisition is running, the waveform display is live. Stopping the acquisition (when you push the RUN/STOP button) freezes the display. In either mode, the waveform display can be scaled or positioned with the vertical and horizontal controls.

Autoset

When you push the AUTOSSET button, the oscilloscope identifies the type of waveform and adjusts controls to produce a usable display of the input signal.

Function	Setting
Acquire mode	Adjusted to Sample or Peak Detect
Display format	Set to YT
Display type	Set to Dots for a video signal, set to Vectors for an FFT spectrum; otherwise, unchanged
Horizontal position	Adjusted
SEC/DIV	Adjusted
Trigger coupling	Adjusted to DC, Noise Reject, or HF Reject
Trigger holdoff	Minimum
Trigger level	Set to 50%
Trigger mode	Auto
Trigger source	Adjusted; refer to page 80; cannot use Autoset on the EXT TRIG signal
Trigger slope	Adjusted
Trigger type	Edge or Video
Trigger Video Sync	Adjusted
Trigger Video Standard	Adjusted
Vertical bandwidth	Full
Vertical coupling	DC (if GND was previously selected); AC for a video signal; otherwise, unchanged
VOLTS/DIV	Adjusted



The Autoset function examines all channels for signals and displays corresponding waveforms.

Autoset determines the trigger source based on the following conditions:

- If multiple channels have signals, channel with the lowest frequency signal
- No signals found, the lowest-numbered channel displayed when Autoset was invoked
- No signals found and no channels displayed, oscilloscope displays and uses channel 1





Sine Wave

When you use the Autoset function and the oscilloscope determines that the signal is similar to a sine wave, the oscilloscope displays the following options:

Sine wave options	Details
 Multi-cycle sine	Displays several cycles with appropriate vertical and horizontal scaling; the oscilloscope displays Cycle RMS, Frequency, Period, and Peak-to-Peak automatic measurements
 Single-cycle sine	Sets the horizontal scale to display about one cycle of the waveform; the oscilloscope displays Mean, and Peak-to-Peak automatic measurements
 FFT	Converts the input time-domain signal into its frequency components and displays the result as a graph of frequency versus magnitude (spectrum); since this is a mathematical calculation, refer to the <i>Math FFT</i> chapter on page 115 for more information
Undo Setup	Causes the oscilloscope to recall the previous setup





Square Wave or Pulse

When you use the Autoset function and the oscilloscope determines that the signal is similar to a square wave or pulse, the oscilloscope displays the following options:

Square wave or pulse options	Details
 Multi-cycle square	Displays several cycles with appropriate vertical and horizontal scaling; the oscilloscope displays Pk-Pk, Mean, Period, and Frequency automatic measurements
 Single-cycle square	Sets the horizontal scale to display about one cycle of the waveform; the oscilloscope displays Min, Max, Mean, and Positive Width automatic measurements
 Rising edge	Displays the edge, and the Rise Time and Peak-to-Peak automatic measurements
 Falling edge	Displays the edge, and the Fall Time and Peak-to-Peak automatic measurements
Undo Setup	Causes the oscilloscope to recall the previous setup

Video Signal

When you use the Autoset function and the oscilloscope determines that the signal is a video signal, the oscilloscope displays the following options:

Video signal options	Details
 All Fields	Displays several fields and the oscilloscope triggers on any field
 All Lines	Displays one complete line with parts of the previous and next line; the oscilloscope triggers on any line
 Line Number	Displays one complete line with parts of the previous and next line; turn the USER SELECT knob to select a specific line number for the oscilloscope to use as a trigger
 Odd Fields	Displays several fields and the oscilloscope triggers only on odd fields
 Even Fields	Displays several fields and the oscilloscope triggers only on even fields
Undo Setup	Causes the oscilloscope to recall the previous setup

NOTE. Video autoset sets the Display Type option to Dot Mode.

Cursors

Push the CURSOR button to display the measurement cursors and Cursor Menu.

Options	Settings	Comments
Type*	Voltage Time Off	Select and display the measurement cursors; Voltage measures amplitude and Time measures time and frequency
Source	CH1 CH2 CH3** CH4** MATH REFA REFB REFC** REFD**	Choose the waveform on which to take the cursor measurements The readouts display this measurement.
Delta		Displays the difference (delta) between the cursors
Cursor 1		Displays cursor 1 location (time is referenced to the trigger position, voltage is referenced to ground)
Cursor 2		Displays cursor 2 location (time is referenced to the trigger position, voltage is referenced to ground)

* For a Math FFT source, measures magnitude and frequency.

** Available only on 4-channel oscilloscopes.

NOTE. *The oscilloscope must display a waveform for the cursors and cursor readouts to appear.*

Key Points

Cursor Movement. Use the CURSOR 1 and CURSOR 2 knobs to move cursors 1 and 2. You can move the cursors only while the Cursor Menu is displayed.

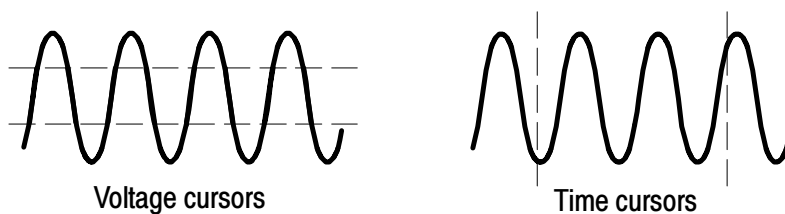

U in Level and Delta Readouts. Vertical sensitivity should match on waveforms used for math operations. If they do not match, and you use cursors to measure the waveform result of a math operation, a U displays that represents unknown.

Default Setup

Push the DEFAULT SETUP button to recall most of the factory option and control settings, but not all. For more information, refer to *Appendix D: Default Setup* on page 175.

Display

Push the DISPLAY button to choose how waveforms are presented and to change the appearance of the entire display.

Options	Settings	Comments
Type	Vectors Dots	Vectors fills the space between adjacent sample points in the display Dots displays only the sample points
Persist	OFF 1 sec 2 sec 5 sec Infinite	Sets the length of time each displayed sample point remains displayed
Format	YT XY	YT format displays the vertical voltage in relation to time (horizontal scale) XY format displays a dot each time a sample is acquired on channel 1 and channel 2 Channel 1 voltage determines the X coordinate of the dot (horizontal) and the channel 2 voltage determines the Y coordinate (vertical)
Contrast Increase		Darkens the display; makes it easier to distinguish a channel waveform from persistence.
Contrast Decrease		Lightens the display

Depending on the type, waveforms will be displayed in three different styles: solid, dimmed, and broken.

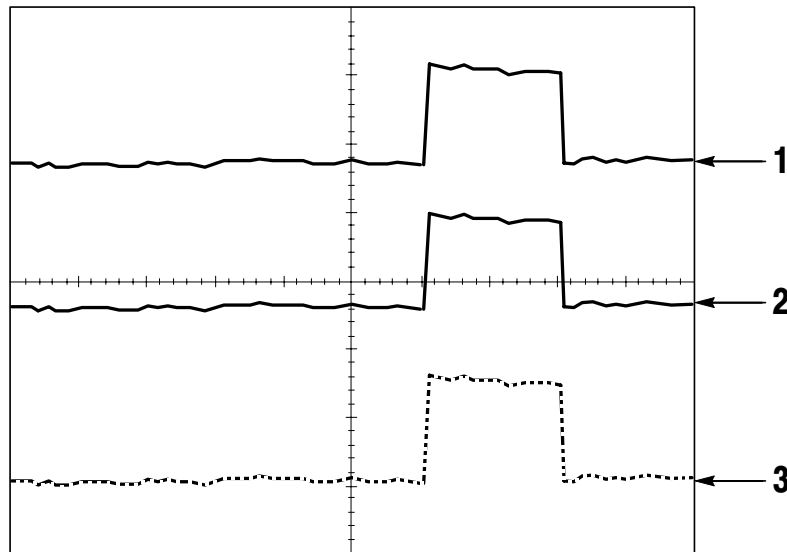

1. A solid waveform indicates a channel (live) waveform display. The waveform remains solid when the acquisition is stopped if no controls are changed that make the display accuracy uncertain.

Changing the vertical and horizontal controls is allowed on stopped acquisitions.

2. For the TDS1000-series (monochrome monitor), a dimmed waveform indicates reference waveforms or waveforms with persistence applied.

For the TDS2000-series (color monitor), reference waveforms appear white and waveforms with persistence applied appear in the same color as the Main waveform, but with less intensity.

3. A broken line indicates the waveform display no longer matches the controls. This happens when you stop the acquisition, and change a control setting that the oscilloscope is not able to apply to the displayed waveform. For example, changing the trigger controls on a stopped acquisition causes a broken-line waveform.

Key Points

Persistence. The TDS1000- and TDS-2000 series oscilloscopes use “dfm” at a “reduced intensity” for persistence.

With Persistence set to Infinite, record points accumulate until a control is changed.

XY Format. Use the XY format to analyze phase differences, such as those represented by Lissajous patterns. The format plots the voltage on channel 1 against the voltage on channel 2, where channel 1 is the horizontal axis and channel 2 is the vertical axis. The oscilloscope uses the untriggered Sample acquisition mode and displays data as dots. The sampling rate is fixed at 1 MS/s.

NOTE. *The oscilloscope can capture a waveform in normal YT mode at any sampling rate. You can view the same waveform in XY mode. To do so, stop the acquisition and change the display format to XY.*

The controls operate as follows:

- The channel 1 VOLTS/DIV and VERTICAL POSITION controls set the horizontal scale and position.
- The channel 2 VOLTS/DIV and VERTICAL POSITION controls continue to set vertical scale and position.

The following functions do not work in XY display format:

- Reference or Math waveforms
- Cursors
- Autoset (resets display format to YT)
- Time base controls
- Trigger controls

Help

Push the HELP button to display the Help menu. The topics cover all the menu options and controls of the oscilloscope. For more information on the Help system, refer to page ix.

Horizontal

You can use the horizontal controls to change the horizontal scale and position of waveforms. The horizontal position readout shows the time represented by the center of the screen, using the time of the trigger as zero. Changing the horizontal scale causes the waveform to expand or contract around the screen center.

Options	Settings	Comments
Main		The main horizontal time base setting is used to display the waveform
Window Zone		Two cursors define a window zone Adjust the Window Zone with the Horizontal Position and SEC/DIV controls
Window		Changes the display to show the waveform segment (expanded to screen width) within the window zone
Trig knob	Level* Holdoff	Selects whether the Trigger Level knob adjusts the trigger level (volts) or holdoff time (sec) The holdoff value is displayed

* **For video trigger with sync on a line number, the USER SELECT (alternative function) knob switches between setting a line number and Trigger Level.**

NOTE. *You can push the horizontal option buttons to switch between an entire waveform display and an enlarged, more detailed part of it.*

The axis for vertical scale is the ground level. A readout near the top right of the screen displays the current horizontal position in seconds. An **M** indicates the Main time base and a **W** indicates the Window time base. The oscilloscope also indicates horizontal position with an arrow icon at the top of the graticule.

Knobs and Buttons

HORIZONTAL POSITION Knob. Use to control the position of the trigger relative to the center of the screen.

SET TO ZERO Button. Use to set the horizontal position to zero.

SEC/DIV Knob (Horizontal Scale). Use to change the horizontal time scale to magnify or compress the waveform.

Key Points

SEC/DIV. If waveform acquisition is stopped (using the **RUN/STOP** or **SINGLE SEQ** button), the **SEC/DIV** control expands or compresses the waveform.

Scan Mode Display (Roll Mode). When the SEC/DIV control is set to 100 ms/div or slower and the trigger mode is set to Auto, the oscilloscope enters the scan acquisition mode. In this mode, the waveform display updates from left to right. There is no trigger or horizontal position control of waveforms during scan mode.

Window Zone. Use the Window Zone option to define a segment of a waveform to see more detail. The Window time base setting cannot be set slower than the Main time base setting.

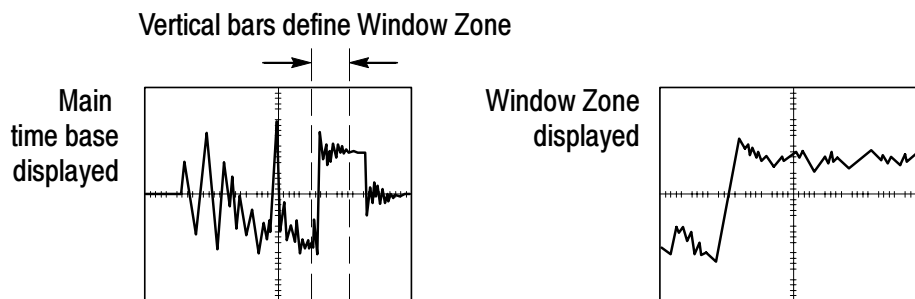

Window. Expands the Window Zone to cover the entire screen.

NOTE. When you change between the Main, Window Zone, and Window views, the oscilloscope erases any waveform saved on the screen through persistence.

Holdoff. Use holdoff to help stabilize the display of aperiodic waveforms. Refer to *Trigger Controls* on page 99 for more information.

Math

Push the MATH MENU button to display the waveform math operations. Push the MATH MENU button again to remove the math waveform display. Refer to page 112 for vertical system descriptions.

Operations	Setting	Comments
- (subtraction)	CH1 - CH2	The channel 2 waveform is subtracted from the channel 1 waveform
	CH2 - CH1	The channel 1 waveform is subtracted from the channel 2 waveform
	CH3 - CH4*	The channel 4 waveform is subtracted from the channel 3 waveform
	CH4 - CH3*	The channel 3 waveform is subtracted from the channel 4 waveform
+ (addition)	CH1 + CH2	Channels 1 and 2 are added together
	CH3 + CH4*	Channels 3 and 4 are added together
FFT	Refer to the <i>Math FFT</i> chapter on page 115	

* Available only on a 4-channel oscilloscope.

Key Points

VOLTS/DIV. Use the VOLTS/DIV control to scale the waveforms of the channels. The math add or subtract waveform is the visual sum or difference of the channel waveforms.

Measure

Push the MEASURE button to access automatic measurements. There are eleven types of measurements available. You can display up to five at a time.

Push the top option button to display the Measure 1 Menu. You can choose the channel on which to take a measurement in the Source option. You can choose the type of measurement to take in the Type option. Push the Back option button to return to the MEASURE Menu and display the selected measurements.

Key Points

Taking Measurements. You can display up to five automatic measurements at a time for a single waveform (or divided among the waveforms). The waveform channel must be on (displayed) to make a measurement.

Automated measurements cannot be taken on reference or math waveforms, or while using XY or scan mode. The measurements update about two times per second.

Measurement type	Definition
Freq	Calculates the frequency of the waveform by measuring the first cycle
Period	Calculates the time of the first cycle

Measurement type	Definition
Mean	Calculates the arithmetic mean voltage over the entire record
Pk-Pk	Calculates the absolute difference between the maximum and minimum peaks of the entire waveform
Cyc RMS	Calculates a true RMS measurement of the first complete cycle of the waveform
Min	Examines the entire 2500 point waveform record and displays the minimum value
Max	Examines the entire 2500 point waveform record and displays the maximum value
Rise Time	Measures the time between 10% and 90% of the first rising edge of the waveform.
Fall Time	Measures the time between 90% and 10% of the first falling edge of the waveform.
Pos Width	Measures the time between the first rising edge and the next falling edge at the waveform 50% level.
Neg Width	Measures the time between the first falling edge and the next rising edge at the waveform 50% level.
None	Does not take any measurement

Print

Push the PRINT button to send the screen data to a printer or computer.

The print function requires the optional TDS2CMA Communications Extension Module. The module includes Centronics, RS-232, and GPIB ports.

Refer to the *TDS2CMA Communications Module* chapter on page 127 for complete operating information. Refer to *Optional Accessories* on page 169 for ordering information.

Probe Check

You can use the Probe Check Wizard to quickly verify that your probe is operating properly.

To use the Probe Check Wizard, push the PROBE CHECK button. If your probe is connected properly, compensated properly, and the Probe entry in the oscilloscope VERTICAL menu is set to match your probe, the oscilloscope will display a PASSED message at the bottom of the screen. Otherwise, the oscilloscope will display directions on the screen to guide you in correcting these problems.

Save/Recall

Push the SAVE/RECALL button to save or recall oscilloscope setups or waveforms.

Setups

Options	Settings	Comments
Setups		Highlighting Setups displays the menus for storing or recalling oscilloscope setups
Setup	1 to 10	Specifies the memory location in which to save the current oscilloscope settings or from which to recall the settings
Save		Completes the save action
Recall		Recalls the oscilloscope settings stored in the location chosen in the Setup field

Key Points

Saving and Recalling Setups. The complete setup is stored in nonvolatile memory. When you recall the setup, the oscilloscope will be in the mode from which the setup was saved.

The oscilloscope saves the current setup if you wait three seconds after the last change before you power off the oscilloscope. The oscilloscope then recalls this setup the next time you apply power.

Recalling the Default Setup. You can push the DEFAULT SETUP button to initialize the oscilloscope to a known setup. To view option and control settings that the oscilloscope recalls when you push this button, refer to *Appendix D: Default Setup* on page 175.

Waveforms

Options	Settings	Comments
Waveforms		Highlighting Waveforms displays the menu for storing or recalling waveforms
Source	CH1 CH2 CH3* CH4* Math	Choose the waveform display to store
Ref	A B C* D*	Choose the reference location to store or recall a waveform
Save**		Stores source waveform to the chosen reference location
Ref(x)	On Off	Displays or removes the reference waveform on the screen

* Available only on 4-channel oscilloscopes.

** Waveform must be displayed to save it as a reference waveform.

Saving and Recalling Waveforms. The oscilloscope must display any waveform that you want to save. Two-channel oscilloscopes can store two reference waveforms in nonvolatile memory. Four-channel oscilloscopes can store four, but only display two at a time.

The oscilloscope can display both reference waveforms and channel waveform acquisitions. Reference waveforms are not adjustable, but the oscilloscope does display the horizontal and vertical scales at the bottom of the screen.

Trigger Controls

You can define the trigger through the Trigger Menu and front-panel controls.

Trigger Types

Three types of triggering are available: Edge, Video, and Pulse Width. A different set of options display for each type of trigger.

Option	Details
Edge (default)	Triggers the oscilloscope on the rising or falling edge of the input signal when it crosses the trigger level (threshold)
Video	Displays NTSC or PAL/SECAM standard composite video waveforms; you trigger on fields or lines of video signals. Refer to <i>Video</i> on page 104
Pulse	Triggers on aberrant pulses. Refer to <i>Pulse Width Trigger</i> on page 105

Edge Trigger

Use Edge triggering to trigger on the edge of the oscilloscope input signal at the trigger threshold.

Options	Settings	Comments
Edge		With Edge highlighted, the rising or falling edge of the input signal is used for the trigger
Source	CH1 CH2 CH3* CH4* Ext Ext/5 AC Line	Select the input source as the trigger signal; see page 102
Slope	Rising Falling	Select to trigger on either the rising or falling edge of the signal
Mode	Auto Normal	Select the type of triggering; see page 101
Coupling	AC DC Noise Reject HF Reject LF Reject	Selects the components of the trigger signal applied to the trigger circuitry; see page 103

* Available only on 4-channel oscilloscopes.

Trigger Frequency Readout

The oscilloscope counts the rate at which trigger events occur to determine trigger frequency and displays the frequency in the lower right corner of the screen.

Key Points

Mode Options.

Mode option	Details
Auto (default)	<p>Forces the oscilloscope to trigger when it does not detect a trigger within a certain amount of time based on the SEC/DIV setting; you can use this mode in many situations, such as to monitor the level of a power supply output</p> <p>Use this mode to let the acquisition free-run in the absence of a valid trigger; this mode allows an untriggered, scanning waveform at 100 ms/div or slower time base settings</p>
Normal	<p>Updates displayed waveforms only when the oscilloscope detects a valid trigger condition; the oscilloscope displays older waveforms until the oscilloscope replaces them with new ones</p> <p>Use this mode when you want to see only valid triggered waveforms; when you use this mode, the oscilloscope does not display a waveform until after the first trigger</p>

To perform a Single Sequence acquisition, push the SINGLE SEQ button.

Source Options.

Source option	Details
Numbered channels	Triggers on a channel whether or not the waveform is displayed
Ext	Does not display the trigger signal; the Ext option uses the signal connected to the EXT TRIG front-panel BNC and allows a trigger level range of +1.6V to -1.6V
Ext/5	Same as Ext option, but attenuates the signal by a factor of five, and allows a trigger level range of +8V to -8V.; this extends the trigger level range
AC Line	<p>This selection uses a signal derived from the power line as the trigger source; trigger coupling is set to DC and the trigger level to 0 volts</p> <p>Use when you need to analyze signals related to the frequency of the power line, such as lighting equipment and power supply devices; the oscilloscope automatically generates the trigger, sets the Trigger Coupling to DC, and sets the Trigger Level to zero volts</p> <p>The AC Line selection is available only when you select the Edge trigger type</p>

NOTE. To view an Ext, Ext/5, or AC Line trigger signal, push and hold down the TRIG VIEW button.

Coupling. Coupling allows you to filter the trigger signal used to trigger an acquisition.

Option	Details
DC	Passes all components of the signal
Noise Reject	Adds hysteresis to the trigger circuitry; this reduces sensitivity which reduces the chance of falsely triggering on noise
HF Reject	Attenuates the high-frequency components above 80 kHz
LF Reject	Blocks the DC component and attenuates the low-frequency components below 300 kHz
AC	Blocks DC components and attenuates signals below 10 Hz

NOTE. *Trigger coupling affects only the signal passed to the trigger system. It does not affect the bandwidth or coupling of the signal displayed on the screen.*

Pretrigger. The trigger position is typically set at the horizontal center of the screen. In this case, you are able to view five divisions of pretrigger information. Adjusting the Horizontal Position of the waveform allows you to see more or less pretrigger information.

Video Trigger

Options	Settings	Comments
Video		With Video highlighted, triggering occurs on an NTSC, PAL, or SECAM standard video signal Trigger coupling is preset to AC
Source	CH1 CH2 CH3* CH4* Ext Ext/5	Selects the input source as the trigger signal Ext and Ext/5 use the signal applied to the EXT TRIG connector as the source
Polarity	Normal Inverted	Normal triggers on the negative edge of the sync pulse and Inverted triggers on the positive edge of the sync pulse
Sync	All Lines Line Number Odd Field Even Field All Fields	Select appropriate video sync Turn the USER SELECT knob to specify a line number when you select Line Number for the Sync option
Standard	NTSC PAL/SECAM	Select the video standard for sync and line number count

* Available only on 4-channel oscilloscopes.

Key Points

Sync Pulses. When you choose Normal Polarity, the trigger always occurs on negative-going sync pulses. If your video signal has positive-going sync pulses, use the Inverted Polarity selection.

Pulse Width Trigger

Use Pulse Width triggering to trigger on aberrant pulses.

Options	Settings	Comments
Pulse		With Pulse highlighted, triggering occurs on pulses that meet the trigger condition defined by the Source, Whe, and Set Pulse Width options
Source	CH1 CH2 CH3* CH4* Ext Ext/5	Select the input source as the trigger signal
When	= ≠ < >	Select how to compare the trigger pulse relative to the value selected in the Set Pulse Width option
Set Pulse Width	33 ns to 10.0 sec	Select this option to use the USER SELECT TRIGGER knob to set a width
Polarity	Positive Negative	Select to trigger on positive or negative pulses
Mode	Auto Normal	Select the type of triggering; Normal mode is best for most Pulse Width trigger applications
Coupling	AC DC Noise Reject HF Reject LF Reject	Selects the components of the trigger signal applied to the trigger circuitry; see Edge Trigger for details on page 100
More		Use to switch between submenu pages

* Available only on 4-channel oscilloscopes.

Trigger Frequency Readout

The oscilloscope counts the rate at which trigger events occur to determine trigger frequency and displays the frequency in the lower right corner of the screen.

Key Points

Trigger When. The pulse width of the source must be ≥ 5 ns for the oscilloscope to detect the pulse.

When options	Details
= ≠	Triggers the oscilloscope when the signal pulse width is equal to or not equal to the specified pulse width within a +5% tolerance
< >	Triggers the oscilloscope when the source signal pulse width is less than or greater than the specified pulse width

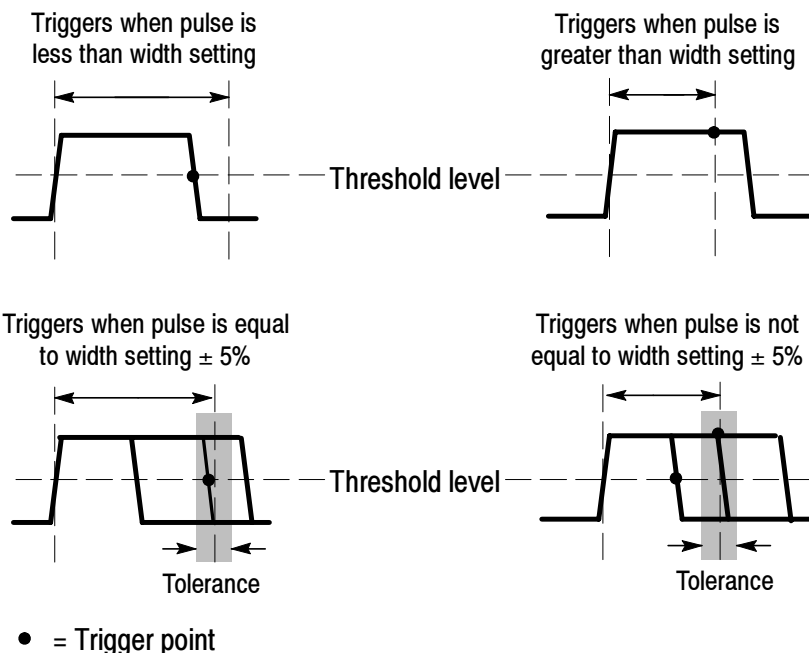

Refer to page 60 for an example of triggering on aberrant pulses.

Knobs and Buttons

LEVEL or USER SELECT Knob. Use to control the Trigger Level, Trigger Holdoff, Video Line Number or Pulse Width. The primary function of this knob is to set the trigger level. When an alternative function is active, the USER SELECT LED lights below the knob.

USER SELECT	Description
Holdoff	Sets the amount of time before another trigger event can be accepted; to switch between the Trigger Level and Holdoff functions, change the Trig Knob option in the Horizontal Menu
Video line number	Sets the oscilloscope to a specific line number when the Trigger Type option is set to Video and the Sync option is set to Line Number
Pulse width	Sets the width of the pulse when the Trigger Type option is set to Pulse and you select the Set Pulse Width option

SET TO 50% Button. Use the SET TO 50% button to quickly stabilize a waveform. The oscilloscope automatically sets the Trigger Level to be about halfway between the minimum and maximum voltage levels. This is useful when you connect a signal to the EXT TRIG BNC and set the trigger source to Ext or Ext/5.

FORCE TRIG Button. Use the FORCE TRIG button to complete the current waveform acquisition whether or not the oscilloscope detects a trigger. This is useful for SINGLE SEQ acquisitions and Normal trigger mode. (In Auto trigger mode, the oscilloscope automatically forces triggers periodically if it does not detect a trigger.)

TRIG VIEW Button. Use the Trigger View mode to have the oscilloscope display the conditioned trigger signal. You can use this mode to see the following types of information: effects of the Trigger Coupling option, AC Line trigger source, and the signal connected to the EXT TRIG BNC.

NOTE. *This is the only button that you must hold down to use. When you hold down the TRIG VIEW button, the only other button you can use is the PRINT button. The oscilloscope disables all other front-panel buttons. The knobs continue to be active.*

Holdoff. You can use the Trigger Holdoff function to produce a stable display of complex waveforms, such as pulse trains. Holdoff is the time between when the oscilloscope detects one trigger and when it is ready to detect another. The oscilloscope will not trigger during the holdoff time. For a pulse train, you can adjust the holdoff time so the oscilloscope triggers only on the first pulse in the train.

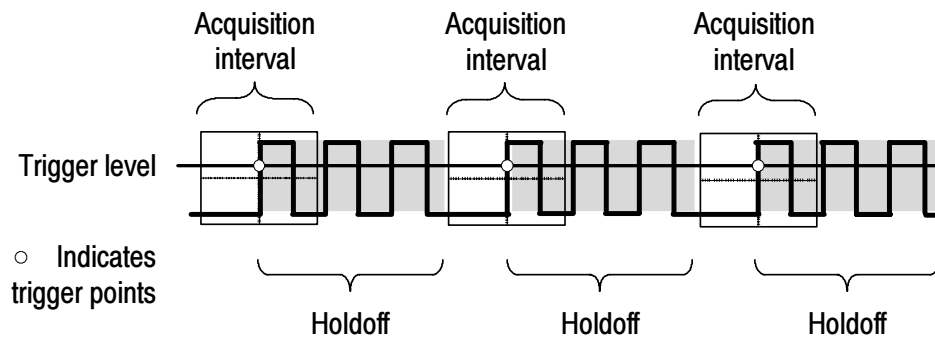

Triggers are not recognized during holdoff time.

To use Trigger Holdoff, push the **HORIZ MENU** button and set the Trig Knob option to Holdoff. The **USER SELECT LED** lights to indicate the alternative function. Turn the knob to adjust the holdoff.

Utility

Push the UTILITY button to display the Utility Menu. The Utility Menu changes with the addition of a TDS2CMA extension module. Refer to the next section for information on the extension module.

Options	Settings	Comments
System Status		Displays summaries of the oscilloscope settings
Options	Display Style*	Displays screen data as black on white, or as white on black
	Printer Setup**	Displays the setup for the printer; see page 131
	RS232 Setup**	Displays the setup for the RS-232 port; see page 134
	GPIB Setup**	Displays the setup for the GPIB port; see page 143
Do Self Cal		Performs a self calibration
Error Log		Displays a list of any errors logged This list is useful when contacting a Tektronix Service Center for help
Language	English French German Italian Spanish Portuguese Japanese Korean Simplified Chinese Traditional Chinese	Selects the display language of the operating system

* Available only on TDS1000-series oscilloscopes.

** Available only with a TDS2CMA module installed.

Key Points

Self Calibration. The self calibration routine optimizes the oscilloscope accuracy for the ambient temperature. For maximum accuracy, you should perform a self cal if the ambient temperature changes by 5° C or more. Follow the directions on the screen.

System Status

Selecting System Status from the Utility Menu displays the menus available for obtaining a list of control settings for each group of oscilloscope controls.

Push any front-panel menu button to remove the status screen.

Options	Comments
Horizontal	Lists horizontal parameters of channels
Vertical	Lists vertical parameters of channels
Trigger	Lists trigger parameters
Misc	Lists the model of the oscilloscope and the software version number If the TDS2CMA module is installed, lists values of the communications parameters

Vertical

You can use the vertical controls to display waveforms, adjust vertical scale and position, and set input parameters. Refer to page 93 for the vertical math descriptions.

Channel Vertical Menus

There is a separate vertical menu for each channel. Each option is set individually for each channel.

Options	Settings	Comments
Coupling	DC	DC passes both AC and DC components of the input signal
	AC	AC blocks the DC component of the input signal and attenuates signals below 10 Hz
	GND	GND disconnects the input signal
BW Limit	20 MHz*	Limits the bandwidth to reduce display noise; filters the signal to reduce noise and other unwanted high frequency components
	Off	
Volts/Div	Coarse	Selects the resolution of the Volts/Div knob Coarse defines a 1-2-5 sequence. Fine changes the resolution to small steps between the coarse settings
	Fine	
Probe	1X	Set to match the type of probe you are using to ensure correct vertical readouts
	10X	
	100X	
	1000X	
Invert	On	Inverts the waveform
	Off	

* Bandwidth is reduced to 7 MHz with a 1X probe.

NOTE. *The oscilloscope vertical response rolls off slowly above its bandwidth (60 MHz, 100 MHz, or 200 MHz, depending on the model, or 20 MHz when the Bandwidth Limit option is set to On). Therefore, the FFT spectrum can show valid frequency information higher than the oscilloscope bandwidth. However, the magnitude information near or above the bandwidth will not be accurate.*

Knobs

VERTICAL POSITION Knobs. Use the VERTICAL POSITION knobs to move the channel waveforms up or down on the screen.

VOLTS/DIV Knobs. Use the VOLTS/DIV knobs to control how the oscilloscope amplifies or attenuates the source signal of channel waveforms. When you turn a VOLTS/DIV knob, the oscilloscope increases or decreases the vertical size of the waveform on the screen with respect to the ground level.

Key Points

GND Coupling. Use GND coupling to display a zero-volt waveform. Internally, the channel input is connected to a zero-volt reference level.

Fine Resolution. The vertical scale readout displays the actual Volts/Div setting while in the fine resolution setting. Changing the setting to coarse does not change the vertical scale until the VOLTS/DIV control is adjusted.

U in Level and Delta Readouts. Vertical sensitivity should match on waveforms used for math operations. If they do not match, and you use cursors to measure the waveform result of a math operation, a U displays that represents unknown units or scaling.

Remove Waveform. To remove a waveform from the display, push the menu button for the channel to display its vertical menu. Push the menu button again to remove the waveform.

NOTE. *You do not have to display a channel waveform to use it as a trigger source or for math operations.*

Math FFT

This chapter contains detailed information on how to use the Math FFT (Fast Fourier Transform). You can use the FFT Math mode to convert a time-domain (YT) signal into its frequency components (spectrum). You can use the Math FFT mode to view the following types of signals:

- Analyze harmonics in power lines
- Measure harmonic content and distortion in systems
- Characterize noise in DC power supplies
- Test impulse response of filters and systems
- Analyze vibration

To use the Math FFT mode, you need to perform the following tasks:

- Set up the source (time-domain) waveform
- Display the FFT spectrum
- Select a type of FFT window
- Adjust the sample rate to display the fundamental frequency and harmonics without aliasing
- Use zoom controls to magnify the spectrum
- Use cursors to measure the spectrum

Setting Up the Time-Domain Waveform

Before you use FFT mode, you need to set up the time-domain (YT) waveform. To do so, follow these steps:

1. Push **AUTOSET** to display a YT waveform.
2. Turn the **VERTICAL POSITION** knob to move the YT waveform to the center vertically (zero divisions).

This ensures that the FFT will show a true DC value.

3. Turn the **HORIZONTAL POSITION** knob to position the part of the YT waveform that you want to analyze in the center eight divisions of the screen.

The oscilloscope calculates the FFT spectrum using the center 2048 points of the time-domain waveform.

4. Turn the **VOLTS/DIV** knob to ensure that the entire waveform remains on the screen. The oscilloscope may display erroneous FFT results (by adding high frequency components) if the entire waveform is not visible.
5. Turn the **SEC/DIV** knob to provide the resolution you want in the FFT spectrum.
6. If possible, set the oscilloscope to display many signal cycles.

If you turn the SEC/DIV knob to select a faster setting (fewer cycles), the FFT spectrum shows a larger frequency range, and reduces the possibility of FFT aliasing, described on page 122. However, the oscilloscope also displays less frequency resolution.

To set up the FFT display, follow these steps:

1. Push the MATH MENU button.
2. Set the Operation option to FFT.
3. Select the Math FFT Source channel.

In many cases, the oscilloscope can produce a useful FFT spectrum even if the YT waveform is not triggered. This is especially true if your signal is periodic or random (noisy).

NOTE. *Transient or burst waveforms should be triggered and positioned as close as possible to center screen.*

Nyquist Frequency

The highest frequency that any real-time digitizing oscilloscope can measure without errors is one-half the sample rate. This frequency is called the Nyquist frequency. Frequency information above the Nyquist frequency is undersampled which causes FFT aliasing, described on page 122.

The math function transforms the center 2048 points of the time-domain waveform into an FFT spectrum. The resulting FFT spectrum contains 1024 points that go from DC (0 Hz) to the Nyquist frequency.

Normally, the display compresses the FFT spectrum horizontally into 250 points, but you can use the FFT Zoom function to expand the FFT spectrum to more clearly see the frequency components at each of the 1024 data points in the FFT spectrum.

NOTE. *The oscilloscope vertical response rolls off slowly above its bandwidth (60 MHz, 100 MHz, or 200 MHz, depending on the model, or 20 MHz when the Bandwidth Limit option is set to ON). Therefore, the FFT spectrum can show valid frequency information higher than the oscilloscope bandwidth. However, the magnitude information near or above the bandwidth will not be accurate.*

Displaying the FFT Spectrum

Push the MATH MENU button to display the Math Menu. Use the options to select the Source channel, Window algorithm, and FFT Zoom factor. You can display only one FFT spectrum at a time.

Math FFT option	Settings	Comments
Source	CH1 CH2 CH3* CH4*	Selects the channel used as the FFT source
Window	Hanning Flattop Rectangular	Selects the FFT window type; for details, refer to page 120
FFT Zoom	X1 X2 X5 X10	Changes the horizontal magnification of the FFT display; for details, refer to page 124

* Available only on 4-channel oscilloscopes.

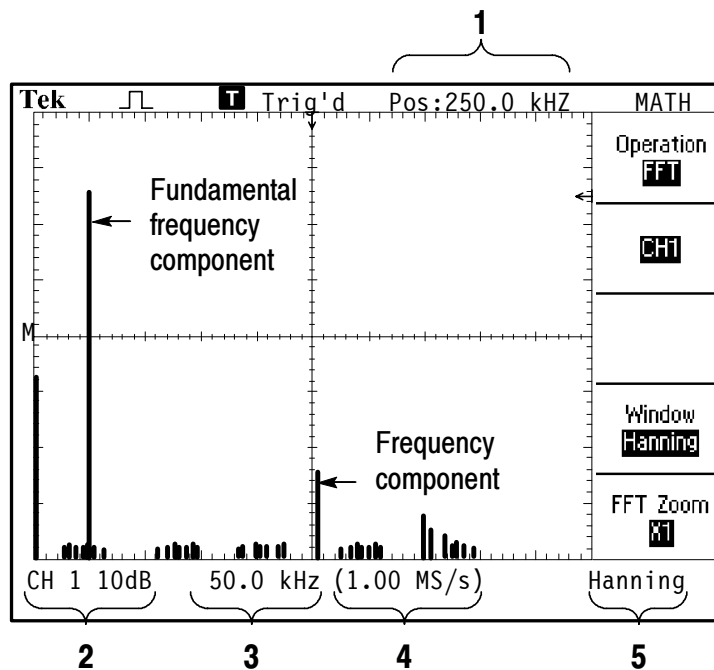

1. Frequency at the center graticule line
2. Vertical scale in dB per division (0 dB = 1 V_{RMS})
3. Horizontal scale in frequency per division
4. Sample rate in number of samples per second
5. FFT window type

Selecting an FFT Window

Windows reduce spectral leakage in the FFT spectrum. The FFT assumes that the YT waveform repeats forever. With an integral number of cycles (1, 2, 3, ...), the YT waveform starts and ends at the same amplitude and there are no discontinuities in the signal shape.

A non-integral number of cycles in the YT waveform causes the signal start and end points to be at different amplitudes. The transitions between the start and end points cause discontinuities in the signal that introduce high-frequency transients.

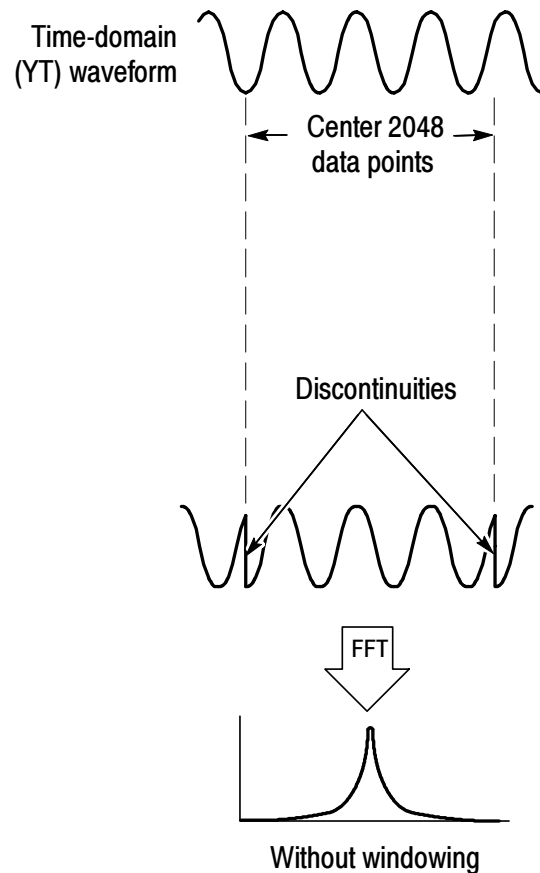

Applying a window to the YT waveform changes the waveform so that the start and stop values are close to each other, reducing the discontinuities.

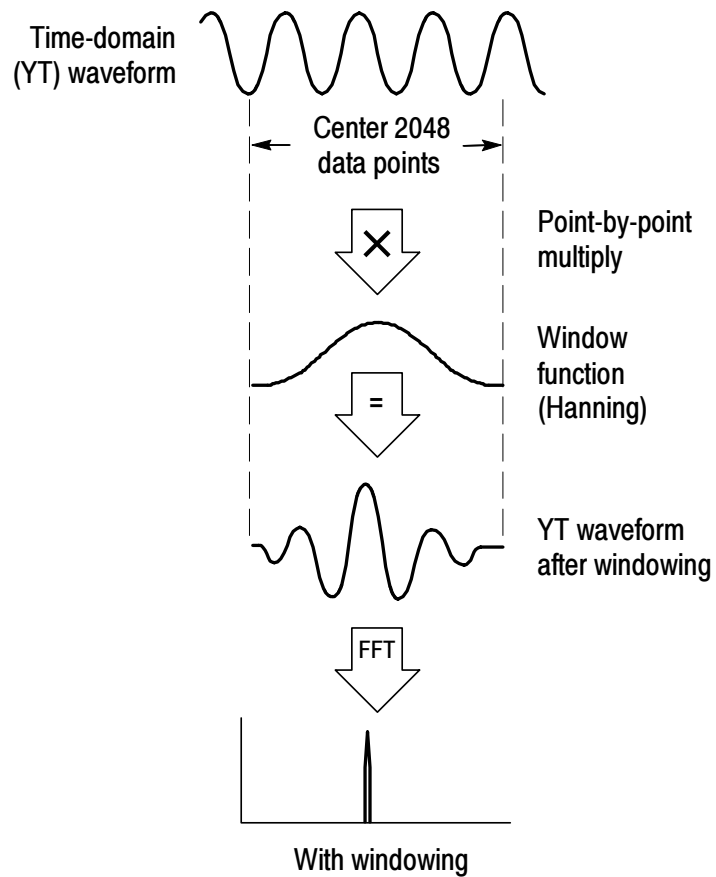

The Math FFT function includes three FFT Window options. There is a trade-off between frequency resolution and amplitude accuracy with each type of window. What you want to measure and your source signal characteristics help you to determine which window to use.

Window	Measure	Characteristics
Hanning	Periodic waveforms	Better frequency, poorer magnitude accuracy than Flattop
Flattop	Periodic waveforms	Better magnitude, poorer frequency accuracy than Hanning
Rectangular	Pulses or transients	Special-purpose window for waveforms that do not have discontinuities. This is essentially the same as no window

FFT Aliasing

Problems occur when the oscilloscope acquires a time-domain waveform containing frequency components that are greater than the Nyquist frequency (refer to *Nyquist Frequency* on page 117). The frequency components that are above the Nyquist frequency are undersampled, appearing as lower frequency components that “fold back” around the Nyquist frequency. These incorrect components are called aliases.

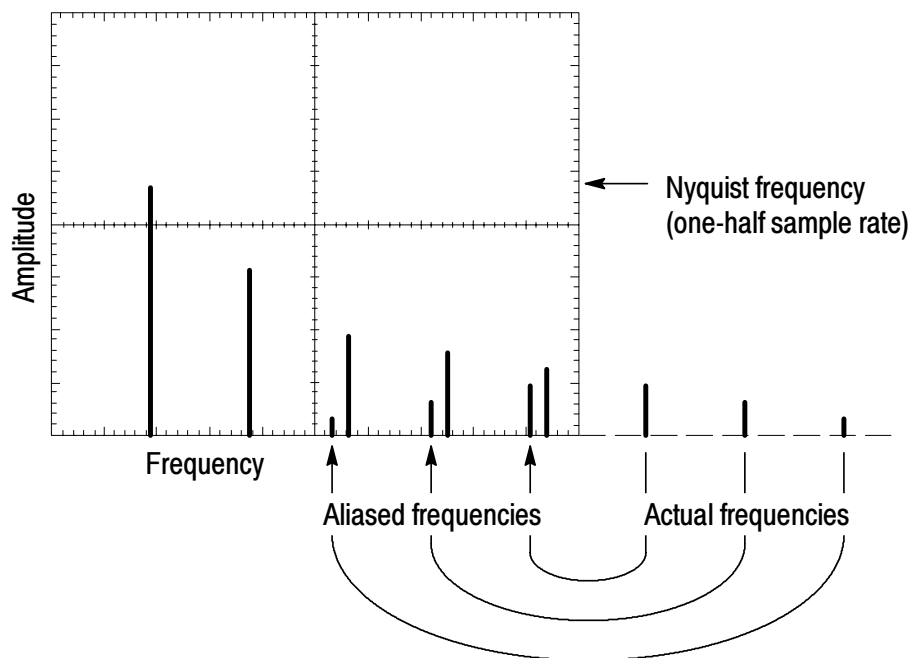

Eliminating Aliases

To eliminate aliases, try the following remedies:

- Turn the SEC/DIV knob to set the sample rate to a faster setting. Since you increase the Nyquist frequency as you increase the sample rate, the aliased frequency components should appear at their proper frequency. If too many frequency components are shown on the screen, you can use the FFT Zoom option to magnify the FFT spectrum.

- If you do not need to view frequencies components above 20 MHz, set the Bandwidth Limit option to On.
- Put an external filter on the source signal to bandwidth limit the source waveform to frequencies below that of the Nyquist frequency.
- Recognize and ignore the aliased frequencies.
- Use zoom controls and the cursors to magnify and measure the FFT spectrum

Magnifying and Positioning an FFT Spectrum

You can magnify and use cursors to take measurements on the FFT spectrum. The oscilloscope includes an FFT Zoom option to magnify horizontally. To magnify vertically, you can use the vertical controls.

Horizontal Zoom and Position

The FFT Zoom option lets you horizontally magnify the FFT spectrum without changing the sample rate. Zoom factors are X1 (default), X2, X5, and X10. At zoom factor X1, and with the waveform centered in the graticule, the left graticule line is at 0 Hz and the right graticule line is at the Nyquist frequency.

When you change the zoom factor, the FFT spectrum is magnified about the center graticule line. In other words, the axis of horizontal magnification is the center graticule line.

Turn the HORIZONTAL POSITION knob clockwise to move the FFT spectrum to the right. Push the SET TO ZERO button to position the center of the spectrum at the center of the graticule.

Vertical Zoom and Position

The channel vertical knobs become zoom and position controls for their respective channels when displaying the FFT spectrum. The VOLTS/DIV knob provides zoom factors of X0.5, X1 (default), X2, X5, and X10. The FFT spectrum is vertically magnified about the M marker (math waveform reference point on the left edge of the screen).

Turn the VERTICAL POSITION knob clockwise to move the spectrum up.

Measuring an FFT Spectrum Using Cursors

You can take two measurements on FFT spectrums: magnitude (in dB) and frequency (in Hz). Magnitude is referenced to 0 dB, where 0 dB equals $1 V_{RMS}$. You can use the cursors to take measurements at any zoom factor.

Push **CURSOR** ► **Source** and select **Math**. Push the **Type** option button to select between **Magnitude** and **Frequency**. Use the **Vertical Position** knobs to move cursors 1 and 2.

Use horizontal cursors to measure magnitude and vertical cursors to measure frequency. The options display the delta between the two cursors, the value at cursor 1 position, and the value at cursor 2 position. Delta is the absolute value of cursor 1 minus cursor 2.

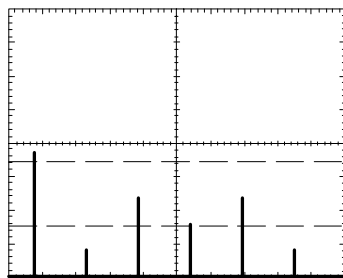

Magnitude cursors

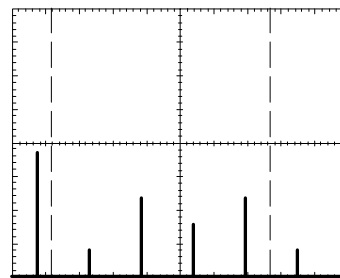

Frequency cursors

You can also take a frequency measurement. To do so, turn the **Horizontal Position** knob to position a frequency component on the center graticule line and read the frequency at the top right of the display.



TDS2CMA Communications Module

This chapter describes how to use the TDS2CMA Communications Extension Module (optional) with a TDS1000- or TDS2000-series oscilloscope. The TDS2CMA module adds Centronics, RS-232 and GPIB communication ports to the oscilloscope. For ordering information, refer to page 169.

This chapter describes how to do the following tasks:

- Install the extension module
- Set up and test the RS-232 interface
- Set up and test the GPIB interface
- Send screen data to an external device (printer or computer)

Installing and Removing an Extension Module

This section describes how to safely remove and install an extension module on your oscilloscope.



CAUTION. *Electrostatic discharge (ESD) can damage components in the module and the oscilloscope. To prevent ESD, follow the next list of precautions when installing, removing, or handling an module.*

After removing a module, install the dummy module cover to protect the contact pins.

- Always power down the oscilloscope before removing or installing the module.
- Handle the module as little as possible.
- Transport and store the module in a static-protected bag or container.
- Do not slide the module over any surface.
- Wear a grounded antistatic wrist strap to discharge the static voltage from your body while installing or removing a module from the oscilloscope.
- Do not touch the oscilloscope module connector pins.
- Do not use any devices capable of generating or holding a static charge in the work area where you install or remove the module.
- Avoid handling the module in areas that have a floor or work-surface covering capable of generating a static charge.
- Make sure that you install the module cover after you remove the module.

Removing an Extension Module

To remove an extension module, refer to the next illustration and follow the previous precautions.

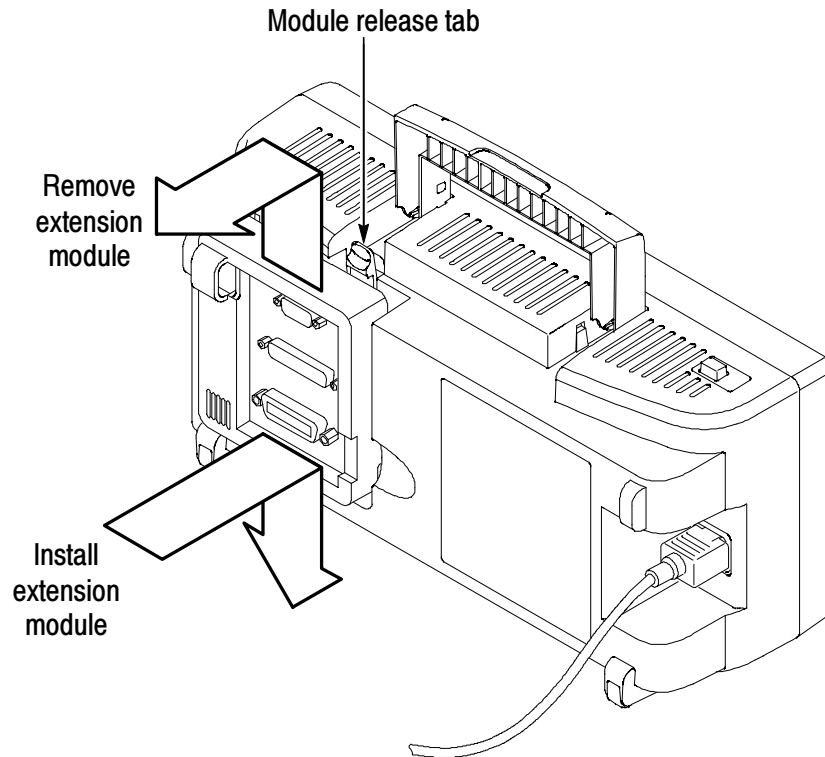

Installing an Extension Module

Make sure that you align the module tabs to the oscilloscope connector pins and press down firmly to seat the module.

Checking Module Installation

To check that the module is correctly installed, power on the oscilloscope. The power-on screen should list the TDS2CMA module and include the message “Power-up Tests Passed.” If the oscilloscope does not recognize the module at power on, follow the steps in *Troubleshooting Module Installation*.

Troubleshooting Module Installation

If the oscilloscope does not recognize the module at power on, follow these steps:

1. Power off the oscilloscope.
2. Follow the ESD precautions on page 128.
3. Disconnect all cables from the module.
4. Remove the module as described on page 129.
5. Examine the oscilloscope connector for bent, broken, or missing pins. If any pins are bent, carefully straighten them.
6. Reinstall the module onto the oscilloscope.
7. Power on the oscilloscope. If the oscilloscope still does not show the module installed, contact the nearest Tektronix service center.

Sending Screen Data to an External Device

The TDS2CMA module lets you send screen data to an external device, such as a controller, printer, or computer.

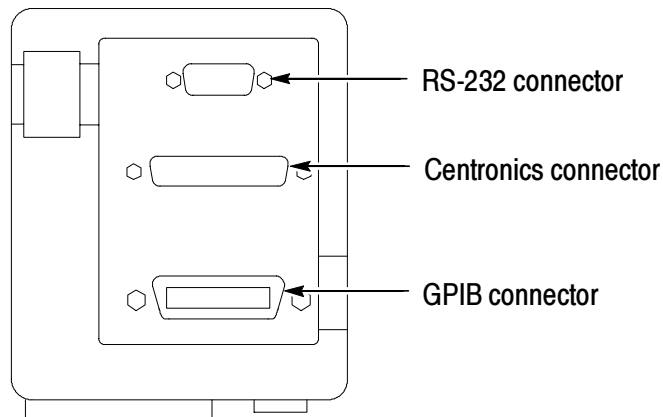

Printer Setup

To setup the module, do the following:

1. Power on the oscilloscope.
2. Push **UTILITY** ► **Options** ► **Printer Setup**.
3. Push the option buttons to change the settings to match those of your printer. The next table lists the settings you can change.

NOTE. *The oscilloscope stores these settings until you change them, even if you push the **DEFAULT SETUP** button.*

Option	Settings	Comments
Layout	Portrait, Landscape	Printer output orientation
Format	Thinkjet, Deskjet, Laser Jet, Bubble Jet, Epson, BMP, PCX, TIFF, RLE, EPSIMAGE, DPU411, DPU412, DPU3445	Type of device connected to the communications port
Port	Centronics, RS-232, GPIB	Communications port used to connect the oscilloscope to a printer or computer
Ink Saver*	On, Off	On prints the screen data on a white background
Abort Printing		Stops sending screen data to the printer

* **Only for TDS2000-series oscilloscopes.**

NOTE. *If you use the RS-232 or GPIB port, you also need to set up the parameters for the port appropriately for your printer.*

Testing the Printer Port

To test the printer port, follow these steps:

1. If you have already connected the oscilloscope to a printer, go to step 4.
2. Power off the oscilloscope and the printer.
3. Connect the oscilloscope to the printer using the appropriate cable.
4. Power on the oscilloscope and the printer.
5. If you have not done so already, define an appropriate printer setup. Refer to page 131.
6. Push the **PRINT** button. The printer should begin printing a copy of the oscilloscope screen within twenty seconds, depending on the selected printer.

Printing Oscilloscope Screen Data

To print the screen data, push the **PRINT** button. The oscilloscope takes a few seconds to capture the screen data. The settings of your printer and print speed determine how long it takes to print the data. Additional time may be required according to the format selected.

NOTE. *You can use the oscilloscope while the printer prints.*

Setting Up and Testing the RS-232 Interface

You may need to set up and test the module RS-232 interface. RS-232 is an 8-bit serial communications standard that lets the oscilloscope communicate with an external RS-232 device such as a computer, terminal, or printer. The standard defines two device types: Data Terminal Equipment (DTE) and Data Communications Equipment (DCE). The oscilloscope is a DTE device.

RS-232 Conventions on page 141 describes RS-232 conventions. *RS-232 Connector Pinout Diagram* on page 142 shows a diagram of the 9-pin RS-232 connector with pin numbers and signal assignments.

Selecting an RS-232 Cable

You need an RS-232 cable to connect the oscilloscope to an external device. You can use the next table to choose the correct cable.

To connect the oscilloscope to	You need this type cable	Tektronix part number
PC/AT or laptop computers	9-pin female to 9-pin female, null modem	012-1379-00
PCs with 25-pin serial port connector	9-pin female to 25-pin female, null modem	012-1380-00
Serial printers, such as an HP Deskjet, and Sun workstations	9-pin female to 25-pin male, null modem	012-1298-00
Telephone modems	9-pin female to 25-pin male, modem	012-1241-00

Connecting an External Device

When you connect the module to an external RS-232 device, follow these guidelines:

- Use the correct cable (refer to the table on page 134).
- Use a cable that is no longer than 50 feet.
- Power off the oscilloscope and the external device before you connect the cable between them.
- Connect the oscilloscope only to a DCE device.
- Check that the oscilloscope signal ground (pin 5) is connected to the external device signal ground.
- Connect the chassis ground of the oscilloscope to the chassis ground of the external device.

RS-232 Settings

To set up the oscilloscope RS-232 interface, follow these steps:

1. Push **UTILITY ► Options ► RS-232**.
2. Push the option buttons to match the settings of your external device. The next table lists the settings you can change.

NOTE. *The oscilloscope stores these settings until you change them, even if you push the **DEFAULT SETUP** button.*

Option	Settings	Comments
Set to Defaults		Sets the RS-232 interface to factory defaults (Baud=9600, Flow=hardflagging, EOL String=LF, Parity=None)
Baud	300, 600, 1200, 2400, 4800, 9600, 19200	Sets the data transmission rate
Flow Control	Hardflagging, Softflagging, None	Sets data flow control (Softflagging = Xon/Xoff, Hardflagging = RTS/CTS). Use hardware flagging when you transfer binary data
EOL String	CR, LF, CR/LF, LF/CR	Sets the end-of-line terminator sent by the oscilloscope; the oscilloscope can receive any EOL string
Parity	None, Even, Odd	Adds an error check bit (ninth bit) to each character

Testing the RS-232 Interface

To test the oscilloscope RS-232 interface, follow these steps:

1. Connect the oscilloscope to a personal computer (PC) using an appropriate RS-232 cable (refer to the table on page 134).
2. Power on the PC.
3. On the PC, run a terminal-emulator program such as Microsoft Windows Hyperterminal. Make sure the PC serial port is set as follows:

Function	Setting
Baud rate	9600
Data flow control	hardflagging
Parity	None

4. Power on the oscilloscope.
5. Connect the oscilloscope probe to the channel 1 input connector. Attach the probe tip and ground lead to the PROBE COMP connectors.

The PROBE COMP signal is a square wave with a frequency of ≈ 1 kHz and a peak voltage of ≈ 5 V. The next figure shows how to connect the probe to the oscilloscope.

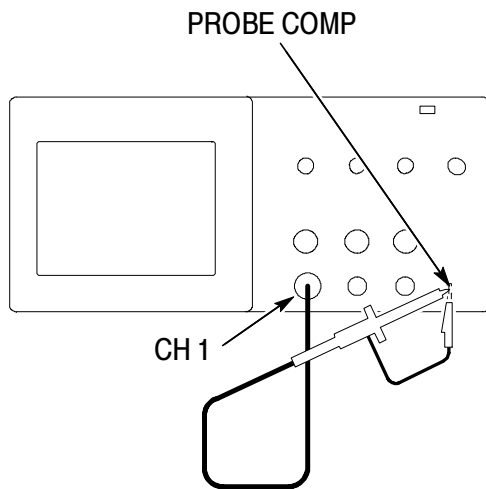

6. On the oscilloscope, push **UTILITY ► Options ► RS-232**.
7. Check that the menu settings match those listed in the table on page 137.
8. From your PC terminal program, type `ID?`, then press the Return or Enter key to send the command. The oscilloscope sends back its identification string, which should look similar to the following:

`ID TEK/TDS 1002,CF:91.1CT,FV:V1.09 TDS2CMA:CMV:V1.04`

If you do not get any response, refer to the troubleshooting steps that start on page 139.
9. Send the command `FACtory` to reset the oscilloscope to factory settings (defaults).

NOTE. For brief information on command entry, refer to page 150.

For complete command information, refer to the programmer manual that came with your extension module.

10. Send the command AUTOSet EXECute to have the oscilloscope automatically acquire the input signal.
11. Send the command MEASUrement:IMMed:SOURCE CH1 to select measurements on channel 1.
12. Send the command MEASUrement:IMMed:TYPE PK2 to set up the voltage measurement.
13. Send the query MEASUrement:IMMed:VALue? to request the measurement result. The oscilloscope will respond with a result similar to 5.16E0, which is the voltage measurement of the PROBE COMP signal using the standard 10X probe.

This completes the RS-232 interface test.

RS-232 Troubleshooting

If the oscilloscope and the external device (computer or printer) have trouble communicating, follow these steps:

1. Verify that the module is working. Refer to *Checking Module Installation* on page 130.

2. Check that you are using the correct RS-232 cable. Determine whether your external device requires a null-modem or a straight-through connection. Refer to the table on page 134 for information about RS-232 cables.
3. Check that the RS-232 cable is firmly connected to both the oscilloscope and the correct port on the external device.
4. Check that the printer or the program on the personal computer is using the same port to which you connected the RS-232 cable. Try your program or printer again.
5. Check that the oscilloscope RS-232 settings match the settings used by the external device:
 - a. Determine the RS-232 settings for the external device.
 - b. On the oscilloscope, push **UTILITY ► Options ► RS-232 Setup**.
 - c. Set the oscilloscope to match the settings of the external device.
 - d. Try your terminal-emulator program or printer again.
6. Try setting both the oscilloscope and the external device to a slower baud rate.

7. If you receive only part of the printer file, try these remedies:
 - a. Lengthen the timeout for the external device
 - b. Make sure the printer is set to receive a binary file, not a text file.

RS-232 Conventions

There are processing conventions that are specific to the RS-232 interface, such as transferring binary data, processing break signals, reporting RS-232 I/O errors, and checking command status.

Transferring Binary Data

To use the RS-232 port to transfer binary data to the oscilloscope, set up the interface as follows:

- Use hardware flagging (RTS/CTS) whenever possible. Hardware flagging guarantees no data loss.
- All eight bits of binary data contain meaningful information. To make sure that all eight bits are received or transmitted, configure the external RS-232 device to receive and transmit eight-bit characters (set the RS-232 word length to eight bits).

Reporting RS-232 I/O Errors

Errors are reported when there is a problem with parity, framing, or input/output buffer overruns. To report errors, the oscilloscope posts an event code. When an error occurs, the oscilloscope discards all input and output and waits for a new command.

Checking Command Status

If you want to check the status of each command sent, you can append an *STB? query after every command and read the response string.

Processing Break Signals

When the oscilloscope senses a break signal on the RS-232 port, it returns DCL followed by the end of line terminator. Internally, the oscilloscope acts as if it received a GPIB <DCL> command, causing the oscilloscope to erase the contents of the input and output buffers and then wait for a new command. Break signals do not change oscilloscope settings or stored data and do not interrupt front-panel operation or nonprogrammable functions.

If a break signal is sent in the middle of a character stream, several characters immediately preceding or following the break can be lost. The controller should wait until it receives the DCL and the end of line terminator string before sending more characters.

RS-232 Connector Pinout Diagram

The next figure shows the pin numbering and signal assignments for the TDS2CMA RS-232 connector.

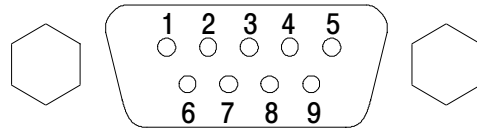

1	No connection	
2	Receive data (RxD)	(input)
3	Transmit data (TxD)	(output)
4	Data terminal ready (DTR)	(output)
5	Signal ground (GND)	
6	Data set ready (DSR)	(input)
7	Request to send (RTS)	(output)
8	Clear to send (CTS)	(input)
9	No connection	

Setting Up and Testing the GPIB Interface

You may need to set up and test the module GPIB interface. GPIB is an 8-bit parallel communications standard that lets the oscilloscope communicate with an external device such as a controller, computer, terminal, or printer.

Connecting to External GPIB Devices

Follow these guidelines when you connect your oscilloscope to a GPIB network:

- Power off the oscilloscope and all external devices before connecting the oscilloscope to the GPIB network.

- Connect the oscilloscope to the GPIB network. Use an appropriate GPIB cable. You can stack cable connectors. The next table lists cables that you can order to connect the oscilloscope to the GPIB network.

Cable type	Tektronix part number
GPIB, 6.6 feet (2 meters)	012-0991-00
GPIB, 3.3 feet (1 meter)	012-0991-01

- Assign a unique device address to the oscilloscope. No two devices can share the same device address. The *GPIB Settings* information describes how to set the oscilloscope GPIB interface.
- Power on at least two-thirds of the GPIB devices while using the network.

GPIB Settings

To set the oscilloscope GPIB interface, follow these steps:

1. If you have not done so yet, connect the oscilloscope to the GPIB network.

2. On the oscilloscope, push **UTILITY ► Options ► GPIB Setup**.
3. Push the **Address** option button to assign a unique address to the oscilloscope.
4. Push the **Bus Connection** option button to have the oscilloscope start or stop using the GPIB bus.

Option	Settings	Comments
Address	0... 30	Sets oscilloscope GPIB bus address
Bus Connection	Talk-Listen, Off-Bus	Select Talk-Listen to start oscilloscope GPIB bus communications. Select Off-Bus to stop oscilloscope GPIB bus communications.

NOTE. *The oscilloscope stores these settings until you change them, even if you push the **DEFAULT SETUP** button.*

Testing the GPIB Interface

To test the oscilloscope GPIB interface, you will need to refer to the documentation that came with your controller.

The following procedure verifies communication with the oscilloscope by acquiring a signal and returning a voltage measurement. This procedure assumes that the oscilloscope is connected to the GPIB network, the oscilloscope has been assigned a unique bus address, and that the controller software is running.

To test the GPIB interface, follow these steps:

1. Connect the oscilloscope probe to the channel 1 input connector. Attach the probe tip and ground lead to the PROBE COMP connectors. The figure on the next page shows how to hook up the probe to the oscilloscope.

The PROBE COMP signal is a square wave with a frequency of ≈ 1 kHz and a peak voltage of ≈ 5 V.

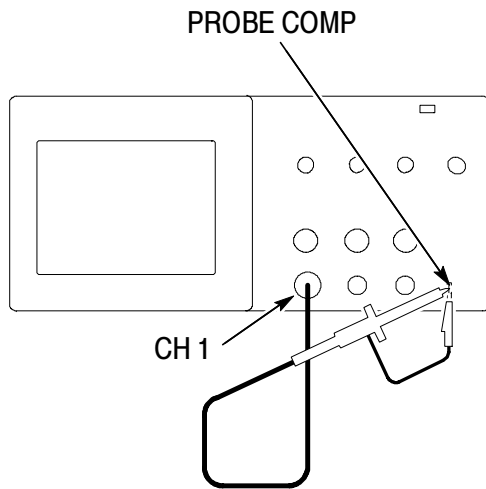

2. In the controller software, send the ID? command to the oscilloscope. The oscilloscope should send back its identification string which looks similar to the following:

```
ID TEK/TDS 1002,CF:91.1CT,FV:V1.09 TDS2CMA:CMV:V1.04
```
3. Send the command FACtory to reset the oscilloscope to factory settings (defaults).

NOTE. For brief information on command entry, refer to page 150.

For complete command information, refer to the programmer manual that came with your extension module.

4. Send the command AUTOSet EXECute to have the oscilloscope automatically acquire the input signal.
5. Send the command MEASUrement:IMMed:SOURCE CH1 to select measurements on channel 1.
6. Send the command MEASUrement:IMMed:TYPE PK2 to set up the voltage measurement.
7. Send the query MEASUrement:IMMed:VALue? to request the measurement result. The oscilloscope will respond with a result similar to 5.16E0, which is the voltage measurement of the PROBE COMP signal using the standard 10x probe.

This completes the GPIB interface test.

GPIB Network Conventions

To achieve a high data transfer rate, the physical distance between devices and the number of devices on the bus are limited. When you create the GPIB network, follow these guidelines:

- Connect the GPIB devices in a star, linear, or combination star/linear network.

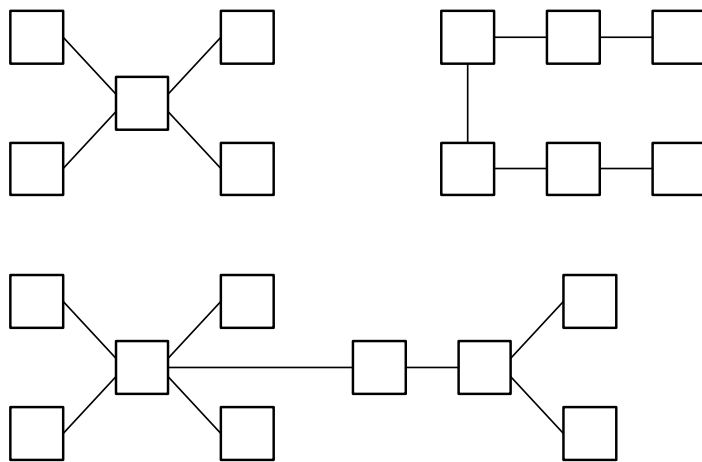

CAUTION. Do not use loop or parallel networks.

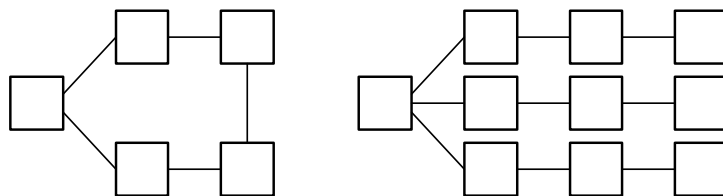

- A maximum separation of 13.2 feet (4 meters) between any two devices and an average separation of 6.6 feet (2 meters) over the entire bus.
- A maximum total cable length of 66 feet (20 meters).
- No more than 15 device loads connected to each bus, with at least two-thirds powered on.
- Assign a unique device address to each device on the network. No two devices can share the same device address.

Command Entry

When you enter oscilloscope commands over the RS-232 or GPIB bus, follow these general rules:

- You can enter commands in upper or lower case.
- You can abbreviate many oscilloscope commands. These abbreviations are shown in uppercase letters. For example, the command ACQUIRE:NUMAVg can be entered simply as ACQ:NUMAV or acq:numav.
- You can precede any command with white space characters. White space characters include any combination of the ASCII control characters 00 through 09 and 0B through 20 hexadecimal (0 through 9 and 11 through 32 decimal).
- The oscilloscope ignores commands that consist of just a combination of white space characters and line feeds.

Refer to the *TDS200-, TDS1000- and TDS2000-Series Digital Oscilloscope Programmer Manual* (071-1075-XX) for more information.

Appendix A: Specifications

All specifications apply to the TDS1000- and TDS2000-series oscilloscopes. P2200 probe specifications appear at the end of this chapter. To verify that the oscilloscope meets specifications, the oscilloscope must first meet the following conditions:

- The oscilloscope must have been operating continuously for twenty minutes within the specified operating temperature.
- You must perform the Do Self Cal operation, accessible through the Utility menu, if the operating temperature changes by more than 5° C.
- The oscilloscope must be within the factory calibration interval

All specifications are guaranteed unless noted “typical.”

Oscilloscope Specifications

Acquisition		
Acquisition Modes	Sample, Peak Detect, and Average	
Acquisition Rate, typical	Up to 180 waveforms per second, per channel (Sample acquisition mode, no measurements)	
Single Sequence	<i>Acquisition Mode</i>	<i>Acquisition Stops After</i>
	Sample, Peak Detect	Single acquisition, all channels simultaneously
	Average	N acquisitions, all channels simultaneously, N is selectable from 4, 16, 64, and 128

Oscilloscope Specifications (Cont.)

Inputs		
Input Coupling	DC, AC, or GND	
Input Impedance, DC Coupled	1 M Ω \pm 2% in parallel with 20 pF \pm 3 pF	
P2200 Probe Attenuation	1X, 10X	
Supported Probe Attenuation Factors	1X, 10X, 100X, 1000X	
Maximum Voltage Between Signal and Common at input BNC	<i>Overvoltage Category</i>	<i>Maximum Voltage</i>
	CAT I and CAT II	300 V _{RMS} , Installation Category II
	CAT III	150 V _{RMS}
	Installation Category II; derate at 20 dB/decade above 100 kHz to 13 V peak AC at 3 MHz* and above. For non-sinusoidal waveforms, peak value must be less than 450 V. Excursion above 300 V should be less than 100 ms duration. RMS signal level including any DC component removed through AC coupling must be limited to 300 V. If these values are exceeded, damage to the instrument may result. Refer to the Overvoltage Category description on page 164.	

* Bandwidth reduced to 6 MHz with a 1X probe.

Oscilloscope Specifications (Cont.)

Inputs			
Channel-to-Channel Common Mode Rejection, typical	TDS1002 and TDS2002	TDS1012, TDS2012, TDS2014, TDS2022 and TDS2024	
	100:1 at 60 Hz 20:1 at 30 MHz*	100:1 at 60 Hz 20:1 at 50 MHz*	
	Measured on MATH Ch1 - Ch2 waveform, with test signal applied between signal and common of both channels, and with the same VOLTS/DIV and coupling settings on each channel Measured on MATH Ch3 - Ch4 waveform for 4-channel models		
Channel-to-Channel Crosstalk	TDS1002 and TDS2002	TDS1012, TDS2012 and TDS2014	TDS2022 and TDS2024
	$\geq 100:1$ at 30 MHz*	$\geq 100:1$ at 50 MHz*	$\geq 100:1$ at 100 MHz*
	Measured on one channel, with test signal applied between signal and common of the other channel, and with the same VOLTS/DIV and coupling settings on each channel		
Vertical			
Digitizers	8-bit resolution (except when set to 2 mV/div), each channel sampled simultaneously		
VOLTS/DIV Range	2 mV/div to 5 V/div at input BNC		
Position Range	2 mV/div to 200 mV/div, ± 2 V > 200 mV/div to 5 V/div, ± 50 V		

* Bandwidth reduced to 6 MHz with a 1X probe.

Oscilloscope Specifications (Cont.)

Vertical			
Analog Bandwidth in Sample and Average modes at BNC or with P2200 probe, DC Coupled	TDS1002 and TDS2002	TDS1012, TDS2012 and TDS2014	TDS2022 and TDS2024
	60 MHz†*	100 MHz†*	200 MHz†* 32° F - 104° F (0° C to +40° C) 160 MHz†* 32° F - 122° F (0° C to +50° C)
	20 MHz* (when vertical scale is set to < 5 mV)		
Analog Bandwidth in Peak Detect mode (50 s/div to 5 μs/div**), typical	TDS1002 and TDS2002	TDS1012, TDS2012, TDS2014, TDS2022 and TDS2024	
	50 MHz†*	75 MHz†*	
	20 MHz* (when vertical scale is set to < 5 mV)		
Selectable Analog Bandwidth Limit, typical	20 MHz*		
Lower Frequency Limit, AC Coupled	≤ 10 Hz at BNC ≤ 1 Hz when using a 10X passive probe		
Rise Time at BNC, typical	TDS1002 and TDS2002	TDS1012, TDS2012 and TDS2014	TDS2022 and TDS2024
	< 5.8 ns	< 3.5 ns	< 2.1 ns
Peak Detect Response**	Captures 50% or greater amplitude of pulses ≥12 ns wide typical (50 s/div to 5 μs/div) in the center 8 vertical divisions		

† **When vertical scale is set to ≥ 5 mV.**

* **Bandwidth reduced to 6 MHz with a 1X probe.**

** **The oscilloscope reverts to Sample mode when the SEC/DIV (horizontal scale) is set from 2.5 μs/div to 5 ns/div on 1 GS/s models, or from 2.5 μs/div to 2.5 ns/div on 2 GS/s models. The Sample mode can still capture 10 ns glitches.**

Oscilloscope Specifications (Cont.)

Vertical		
DC Gain Accuracy	$\pm 3\%$ for Sample or Average acquisition mode, 5 V/div to 10 mV/div	
	$\pm 4\%$ for Sample or Average acquisition mode, 5 mV/div and 2 mV/div	
DC Measurement Accuracy, Average Acquisition Mode	<i>Measurement Type</i>	<i>Accuracy</i>
	Average of ≥ 16 waveforms with vertical position at zero	$\pm(3\% \times \text{reading} + 0.1 \text{ div} + 1 \text{ mV})$ when 10 mV/div or greater is selected
	Average of ≥ 16 waveforms with vertical position not at zero	$\pm[3\% \times (\text{reading} + \text{vertical position}) + 1\% \text{ of vertical position} + 0.2 \text{ div}]$ Add 2 mV for settings from 2 mV/div to 200 mV/div Add 50 mV for settings from > 200 mV/div to 5 V/div
Volts Measurement Repeatability, Average Acquisition Mode	Delta volts between any two averages of ≥ 16 waveforms acquired under same setup and ambient conditions	$\pm(3\% \times \text{reading} + 0.05 \text{ div})$

Oscilloscope Specifications (Cont.)

Horizontal		
Sample Rate Range	TDS1002, TDS1012, TDS2002, TDS2012 and TDS2014	TDS2022 and TDS2024
	5 S/s to 1 GS/s	5 S/s to 2 GS/s
Waveform Interpolation	(sin x)/x	
Record Length	2500 samples for each channel	
SEC/DIV Range	TDS1002, TDS1012, TDS2002, TDS2012 and TDS2014	TDS2022 and TDS2024
	5 ns/div to 50 s/div, in a 1, 2.5, 5 sequence	2.5 ns/div to 50 s/div, in a 1, 2.5, 5 sequence
Sample Rate and Delay Time Accuracy	±50 ppm over any ≥1 ms time interval	
Delta Time Measurement Accuracy (Full Bandwidth)	<i>Conditions</i>	<i>Accuracy</i>
	Single-shot, Sample mode	±(1 sample interval + 100 ppm × reading + 0.6 ns)
	> 16 averages	±(1 sample interval + 100 ppm × reading + 0.4 ns)
	Sample interval = s/div ÷ 250	
Position Range	TDS1002, TDS1012, TDS2002, TDS2012 and TDS2014	
	5 ns/div to 10 ns/div	(-4 div × s/div) to 20 ms
	25 ns/div to 100 μs/div	(-4 div × s/div) to 50 ms
	250 μs/div to 50 s/div	(-4 div × s/div) to 50 s
	TDS2022 and TDS2024	
	2.5 ns/div to 5 ns/div	(-4 div × s/div) to 20 ms

Oscilloscope Specifications (Cont.)

Trigger			
Trigger Sensitivity, Edge Trigger Type	<i>Coupling</i>	<i>Sensitivity</i>	
	DC	CH1, CH2, CH3, CH4	1 div from DC to 10 MHz*, 1.5 div from 10 MHz* to Full
		EXT	200 mV from DC to 100 MHz*, 350 mV from 100 MHz to 200 MHz*
		EXT/5	1 V from DC to 100 MHz*, 1.5 V from 100 MHz to 200 MHz*
Trigger Sensitivity, Edge Trigger Type, typical	<i>Coupling</i>	<i>Sensitivity</i>	
	AC	Same as DC at 50 Hz and above	
	NOISE REJ	Reduces the DC-coupled trigger sensitivity by 2 times for > 10 mv/div to 5 V/div	
	HF REJ	Same as the DC-coupled limit from DC to 7 kHz, attenuates signals above 80 kHz	
	LF REJ	Same as the DC-coupled limits for frequencies above 300 kHz, attenuates signals below 300 kHz	
Trigger Level Range	<i>Source</i>	<i>Range</i>	
	CH1, CH2, CH3, CH4	±8 divisions from center of screen	
	EXT	±1.6 V	
	EXT/5	±8 V	

* Bandwidth reduced to 6 MHz with a 1X probe.

Oscilloscope Specifications (Cont.)

Trigger									
Trigger Level Accuracy, typical	Accuracies are for signals having rise and fall times ≥ 20 ns								
	<table border="1"> <thead> <tr> <th><i>Source</i></th> <th><i>Accuracy</i></th> </tr> </thead> <tbody> <tr> <td>Internal</td> <td>$\pm 0.2 \text{ div} \times \text{volts/div}$ within ± 4 divisions from center screen</td> </tr> <tr> <td>EXT</td> <td>$\pm (6\% \text{ of setting} + 40 \text{ mV})$</td> </tr> <tr> <td>EXT/5</td> <td>$\pm (6\% \text{ of setting} + 200 \text{ mV})$</td> </tr> </tbody> </table>	<i>Source</i>	<i>Accuracy</i>	Internal	$\pm 0.2 \text{ div} \times \text{volts/div}$ within ± 4 divisions from center screen	EXT	$\pm (6\% \text{ of setting} + 40 \text{ mV})$	EXT/5	$\pm (6\% \text{ of setting} + 200 \text{ mV})$
	<i>Source</i>	<i>Accuracy</i>							
	Internal	$\pm 0.2 \text{ div} \times \text{volts/div}$ within ± 4 divisions from center screen							
EXT	$\pm (6\% \text{ of setting} + 40 \text{ mV})$								
EXT/5	$\pm (6\% \text{ of setting} + 200 \text{ mV})$								
SET LEVEL TO 50%, typical	Operates with input signals ≥ 50 Hz								
Default Settings, Video Trigger	Coupling is AC and Auto except for a single sequence acquisition								
Sensitivity, Video Trigger Type, typical	Composite video signal								
	<table border="1"> <thead> <tr> <th><i>Source</i></th> <th><i>Range</i></th> </tr> </thead> <tbody> <tr> <td>Internal</td> <td>Pk-pk amplitude of 2 divisions</td> </tr> <tr> <td>EXT</td> <td>400 mV</td> </tr> <tr> <td>EXT/5</td> <td>2 V</td> </tr> </tbody> </table>	<i>Source</i>	<i>Range</i>	Internal	Pk-pk amplitude of 2 divisions	EXT	400 mV	EXT/5	2 V
	<i>Source</i>	<i>Range</i>							
	Internal	Pk-pk amplitude of 2 divisions							
EXT	400 mV								
EXT/5	2 V								
Signal Formats and Field Rates, Video Trigger Type	Supports NTSC, PAL, and SECAM broadcast systems for any field or any line								
Holdoff Range	500 ns to 10 s								

Oscilloscope Specifications (Cont.)

Pulse Width Trigger	
Pulse Width Trigger modes	Trigger when < (Less than), > (Greater than), = (Equal), or \neq (Not Equal); Positive pulse or Negative pulse
Pulse Width Trigger Point	<p>Equal: The oscilloscope triggers when the trailing edge of the pulse crosses the trigger level.</p> <p>Not Equal: If the pulse is narrower than the specified width, the trigger point is the trailing edge. Otherwise, the oscilloscope triggers when a pulse continues longer than the time specified as the Pulse Width.</p> <p>Less than: The trigger point is the trailing edge.</p> <p>Greater than (also called time-out trigger): The oscilloscope triggers when a pulse continues longer than the time specified as the Pulse Width.</p>
Pulse Width Range	Selectable from 33 ns to 10 s
Pulse Width	16.5 ns or 1 part per thousand, whichever is larger
Equal Guardband	$t > 330 \text{ ns}: \pm 5\% \leq \text{guardband} < \pm(5.1\% + 16.5 \text{ ns})$ $t \leq 330 \text{ ns}: \text{guardband} = \pm 16.5 \text{ ns}$
Not Equal Guardband	$t \leq 330 \text{ ns}: \text{guardband} = \pm 16.5 \text{ ns}$ $165 \text{ ns} < t \leq 330 \text{ ns}: \text{guardband} = -16.5 \text{ ns}/+33 \text{ ns}$ $t \leq 165 \text{ ns}: \text{guardband} = \pm 16.5 \text{ ns}$

Oscilloscope Specifications (Cont.)

Trigger Frequency Counter	
Readout Resolution	6 digits
Accuracy (typical)	± 51 ppm including all frequency reference errors and ± 1 count errors
Frequency Range	AC coupled, 10 Hz minimum to rated bandwidth
Signal Source	<p>Pulse Width or Edge Trigger modes: all available trigger sources</p> <p>The Frequency Counter measures trigger source at all times, including when the oscilloscope acquisition is halted due to changes in the run status, or acquisition of a single shot event has completed.</p> <p>Pulse Width Trigger mode: The oscilloscope counts pulses of significant magnitude inside the 250 ms measurement window that qualify as triggerable events, such as narrow pulses in a PWM pulse train if set to < mode and the width is set to a relatively small time.</p> <p>Edge Trigger mode: The oscilloscope counts all edges of sufficient magnitude and correct polarity.</p> <p>Video Trigger mode: The Frequency Counter does not operate.</p>

Oscilloscope Specifications (Cont.)

Measurements	
Cursors	Voltage difference between cursors (ΔV) Time difference between cursors (ΔT) Reciprocal of ΔT in Hertz ($1/\Delta T$)
Automatic Measurements	Frequency, Period, Mean, Pk-Pk, Cycle RMS, Min, Max, Rise Time, Fall Time, Pos Width, Neg Width

Oscilloscope General Specifications

Display	
Display Type	5.7 in. (145 mm) (diagonal liquid crystal
Display Resolution	320 horizontal by 240 vertical pixels
Display Contrast	Adjustable, temperature compensated
Backlight Intensity, typical	65 cd/m ²
Probe Compensator Output	
Output Voltage, typical	5 V into $\geq 1 \text{ M}\Omega$ load
Frequency, typical	1 kHz
Power Source	
Source Voltage	100 - 120 VAC _{RMS} ($\pm 10\%$) from 45 Hz through 440 Hz, CAT II 120 - 240 VAC _{RMS} ($\pm 10\%$) from 45 Hz through 66 Hz, CAT II
Power Consumption	Less than 30 W
Fuse	1 A, T rating, 250 V

Oscilloscope General Specifications (Cont.)

Environmental		
Temperature	Operating	32° F - 122° F (0° C to +50° C)
	Nonoperating	-40° F - 159.8° F (-40° C to +71° C)
Cooling Method	Convection	
Humidity	+104° F or below (+40° C or below)	≤ 90% relative humidity
	106° F - 122° F (+41° C to +50° C)	≤ 60% relative humidity
Altitude	Operating and Nonoperating	3,000 m (10,000 ft)
Random Vibration	Operating	0.31 g _{RMS} from 5 Hz to 500 Hz, 10 minutes on each axis
	Nonoperating	2.46 g _{RMS} from 5 Hz to 500 Hz, 10 minutes on each axis
Mechanical Shock	Operating	50 g, 11 ms, half sine
Mechanical		
Size	Height	151.4 mm (5.96 in.)
	Width	323.8 mm (12.75 in.)
	Depth	124.5 mm (4.90 in.)
Weight (approximate)	When packaged for domestic shipment	3.6 kg (8.0 lbs)

Oscilloscope EMC Certifications and Compliances

European Union	<p>Meets the intent of Directive 89/336/EEC for Electromagnetic Compatibility. Compliance was demonstrated to the following specifications as listed in the Official Journal of the European Communities:</p> <p>EN 61326, EMC requirements for Class A electrical equipment for measurement, control, and laboratory use^{1,2}</p> <p>IEC 61000-4-2, Electrostatic discharge immunity (Performance criterion B)</p> <p>IEC 61000-4-3, RF electromagnetic field immunity (Performance criterion A)³</p> <p>IEC 61000-4-4, Electrical fast transient/burst immunity (Performance criterion B)</p> <p>IEC 61000-4-5, Power line surge immunity (Performance criterion B)</p> <p>IEC 61000-4-6, Conducted RF immunity (Performance criterion A)⁴</p> <p>IEC 61000-4-11, Voltage dips and interruptions immunity (Performance criterion B)</p> <p>EN 61000-3-2, AC power line harmonic emissions</p>
----------------	--

- 1 Emissions that exceed the levels required by this standard may occur when this equipment is connected to a test object.**
- 2 To ensure compliance to the standards listed above, attach only high quality shielded cables to this instrument. High quality shielded cables typically are braid and foil types that have low impedance connections to shielded connectors at both ends.**
- 3 The increase in trace noise while subjected to a test field (3 V/m over the frequency range 80 MHz to 1 GHz, with 80% amplitude modulation at 1 kHz) is not to exceed 2 major divisions peak-to-peak. Ambient conducted fields may induce triggering when the trigger threshold is offset less than 1 major division from ground reference.**
- 4 The increase in trace noise while subjected to a test field (3 V/m over the frequency range 150 kHz to 80 MHz, with 80% amplitude modulation at 1 kHz) is not to exceed 1 major division peak-to-peak. Ambient conducted fields may induce triggering when the trigger threshold is offset less than 0.5 major divisions from ground reference.**

Oscilloscope EMC Certifications and Compliances (Cont.)

Australia/New Zealand	Meets the intent of Australian EMC Framework as demonstrated to the following specification: AS/NZS 2064.1/2
U.S.A.	Emissions comply with FCC Code of Federal Regulations 47, Part 15, Subpart B, Class A Limits

Oscilloscope Safety Certifications and Compliances

Certifications	CAN/CSA C22.2 No. 1010.1-92 UL3111-1, First Edition
CSA Certified Power Cords	CSA Certification includes the products and power cords appropriate for use in the North America power network. All other power cords supplied are approved for the country of use.
Pollution Degree 2	Do not operate in environments where conductive pollutants may be present.
Overvoltage Category	Category: Examples of Products in this Category: CAT III Distribution-level mains, fixed installation CAT II Local-level mains, appliances, portable equipment CAT I Signal levels in special equipment or parts of equipment, telecommunications, electronics

Adjustment (Factory Calibration) Interval

The recommended calibration interval is one year

Oscilloscope General Certifications and Compliances

Russian Federation	This product was certified by the GOST ministry of Russia to be in compliance with all applicable EMC regulations.
Peoples Republic of China	This product has received the Chinese Metrology Certification (CMC)

P2200 Probe Specifications

Electrical characteristics	10X position	1X position
Bandwidth	DC to 200 MHz	DC to 6 MHz
Attenuation ratio	10:1 \pm 2%	1:1 \pm 2%
Compensation Range	18 pf-35 pf	Compensation is fixed; correct for all oscilloscopes with 1 M Ω input
Input Resistance	10 M Ω \pm 3% at DC	1 M Ω \pm 3% at DC
Input Capacitance	14.5 pf-17.5 pf	80 pf-110 pf
Rise time, typical	< 2.2 ns	< 50.0 ns
Maximum input voltage ¹	10X position	300 V _{RMS} CAT I or 300 V DC CAT I 300 V _{RMS} CAT II or 300 V DC CAT II 100 V _{RMS} CAT III or 100 V DC CAT III 420 V peak, <50% DF, <1 s PW 670 V peak, <20% DF, <1 s PW
	1X position	150 V _{RMS} CAT I or 150 V DC CAT I 150 V _{RMS} CAT II or 150 V DC CAT II 100 V _{RMS} CAT III or 100 V DC CAT III 210 V peak, <50% DF, <1 s PW 330 V peak, <20% DF, <1 s PW
	300 V _{RMS} , Installation Category II; derate at 20 dB/decade above 900 kHz to 13 V peak AC at 3 MHz and above. For non-sinusoidal waveforms, peak value must be less than 450 V. Excursion above 300 V should be less than 100 ms duration. RMS signal level including any DC component removed through AC coupling must be limited to 300 V. If these values are exceeded, damage to the instrument may result. Refer to the Overvoltage Category on the next page.	

¹ As defined in EN61010-1 on the next page.

P2200 Probe Specifications (Cont.)

Certifications and Compliances

EC Declaration of Conformity	Compliance was demonstrated to the following specification as listed in the Official Journal of the European Communities: Low Voltage Directive 73/23/EEC as amended by 93/68/EEC:	
	EN 61010-1/A2	Safety requirements for electrical equipment for measurement, control, and laboratory use
	EN61010-2-031:1994	Particular requirements for hand-held probe assemblies for electrical measurement and test
Overvoltage Category	Category	Examples of Products in this Category
	CAT III	Distribution-level mains, fixed installation
	CAT II	Local-level mains, appliances, portable equipment
	CAT I	Signal levels in special equipment or parts of equipment, telecommunications, electronics
Pollution Degree 2	Do not operate in environments where conductive pollutants may be present.	
Safety	UL3111-1, First Edition & UL3111-2-031, First Edition CSA C22.2 No. 1010.1-92 & CAN/CSA C22.2 No. 1010.2.031-94 IEC61010-1/A2 IEC61010-2-031 Pollution Degree 2	

P2200 Probe Specifications (Cont.)**Environmental characteristics**

Temperature	Operating	32° F - 122° F (0° C to +50° C)
	Nonoperating	-40° F - 159.8° F (-40° C to +71° C)
Cooling Method	Convection	
Humidity	+104° F (+40° C) or below	≤ 90% relative humidity
	+105° F - 122° F (+41° C to +50° C)	≤ 60% relative humidity
Altitude	Operating	10,000 ft (3,000 m)
	Nonoperating	40,000 ft (15,000 m)

Appendix B: Accessories

All accessories (standard and optional) are available by contacting your local Tektronix field office.

Standard Accessories



P2200 1X, 10X Passive Probes. The P2200 passive probes have a 6 MHz bandwidth with a rating of 150 V CAT II when the switch is in the 1X position, and a 200 MHz bandwidth with a rating of 300 V CAT II when the switch is in the 10X position.

A probe instructions manual is included.

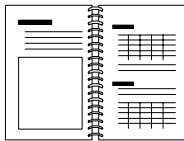

TDS1000- and TDS2000-Series Oscilloscope User Manual.

A single user manual is included. Refer to the Optional Accessories for a complete list of available language manuals.

Optional Accessories

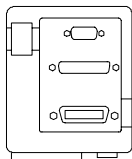

TDS2CMA Communications Extension Module. The TDS2CMA Communications module plugs directly into the rear panel of any TDS1000- or TDS2000-Series oscilloscope. This module provides full GPIB and RS-232 compatibility and a Centronics port for printing screen data.

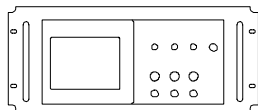

RM2000 Rackmount Kit. The RM2000 Rackmount Kit lets you install a TDS1000- or TDS2000-Series oscilloscope into an industry-standard 19 inch rack. The rackmount kit requires seven inches of vertical rack space. You can turn the oscilloscope power on or off from the front of the rackmount kit. The rackmount kit does not have slide-out capability.

Optional Accessories (Cont.)

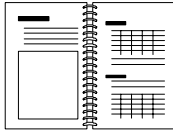

TDS200-, TDS1000- and TDS2000-Series Digital Oscilloscope Programmer Manual. The programmer manual (071-1075-XX English) provides command and syntax information.

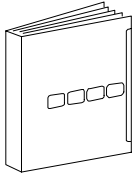

TDS1000- and TDS2000-Series Digital Storage Oscilloscope Service Manual. The service manual (071-1076-XX, English) provides module-level repair information.

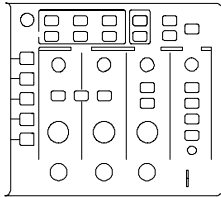

2-channel

TDS1000- and TDS2000-Series Digital Storage Oscilloscope User Manuals. The User manual is available in these languages:

English	071-1064-XX
French	071-1065-XX*
Italian	071-1066-XX*
German	071-1067-XX*
Spanish	071-1068-XX*
Japanese	071-1069-XX*
Portuguese	071-1070-XX*
Simplified Chinese	071-1071-XX*
Traditional Chinese	071-1072-XX*
Korean	071-1073-XX*
Russian	071-1074-XX

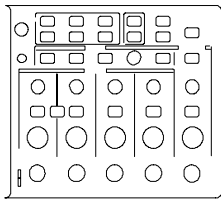

4-channel

***These manuals contain a language overlay for the front-panel controls.**

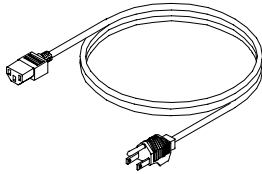

P2200 Probe Instructions Manual. The P2200 probe manual (071-1102-XX, English) provides information on the probe and probe accessories.

Optional Accessories (Cont.)

International Power Cords. In addition to the power cord shipped with your instrument, you can obtain the following cords:

Option A0, North American	120 V, 60 Hz	161-0066-00
Option A1, European	230 V, 50 Hz	161-0066-09
Option A2, United Kingdom	230 V, 50 Hz	161-0066-10
Option A3, Australian	240 V, 50 Hz	161-0066-11
Option A5, Switzerland	230 V, 50 Hz	161-0154-00
Option AC, China	220 V, 50 Hz	161-0304-00

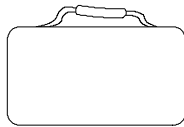

Soft Case. The soft case (AC220) protects the instrument from damage and provides space for probes, power cord, and manuals.

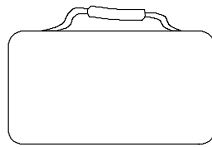

Transit Case. The transit case (HCTDS32) provides shock, vibration, impact and moisture protection for the instrument when you transport it from one place to another. The required soft case fits inside the transit case.

Appendix C: General Care and Cleaning

General Care

Do not store or leave the instrument where the LCD display will be exposed to direct sunlight for long periods of time.



CAUTION. *To avoid damage to the instrument or probes, do not expose them to sprays, liquids, or solvents.*

Cleaning

Inspect the instrument and probes as often as operating conditions require. To clean the exterior surface, perform the following steps:

1. Remove loose dust on the outside of the instrument and probes with a lint-free cloth. Use care to avoid scratching the clear plastic display filter.
2. Use a soft cloth dampened with water to clean the instrument. Use an aqueous solution of 75% isopropyl alcohol for more efficient cleaning.



CAUTION. *To avoid damage to the surface of the instrument or probes, do not use any abrasive or chemical cleaning agents.*

Appendix D: Default Setup

This appendix describes the options, buttons and controls that change settings when you push the DEFAULT SETUP button. For a list of settings that do not change, refer to page 178.

NOTE. *When you push the DEFAULT SETUP button, the oscilloscope displays the CH1 waveform and removes all other waveforms.*

Default settings

Menu or system	Option, button or knob	Default setting
ACQUIRE	(three mode options)	Sample
	Averages	16
	RUN/STOP	RUN
CURSOR	Type	Off
	Source	CH1
	Horizontal (voltage)	+/- 3.2 divs
	Vertical (time)	+/- 4 divs
DISPLAY	Type	Vectors
	Persist	Off
	Format	YT
HORIZONTAL	Window	Main
	Trig Knob	Level
	POSITION	0.00 s
	SEC/DIV	500 μ s
	Window Zone	50 μ s

Default setup (Cont.)

Menu or control	Option	Default setting
MATH	Operation	CH1 - CH2
	FFT operation: Source	CH1
	Window	Hanning
	FFT Zoom	X1
MEASURE	Source	CH1
	Type	None
TRIGGER (Edge)	Type	Edge
	Source	CH1
	Slope	Rising
	Mode	Auto
	Coupling	DC
	LEVEL	0.00 V
TRIGGER (Video)	Type	Video
	Source	CH1
	Polarity	Normal
	Sync	All Lines
	Standard	NTSC

Default setup (Cont.)

Menu or control	Option	Default setting
TRIGGER (Pulse)	Type	Pulse
	Source	CH1
	When	=
	Set Pulse Width	1.00 ms
	Polarity	Positive
	Mode	Auto
	Coupling	DC
Vertical system, all channels	Coupling	DC
	BW Limit	Off
	Volts/Div	Coarse
	Probe	10X
	Invert	Off
	POSITION	0.00 divs (0.00 V)
	VOLTS/DIV	1.00 V

The DEFAULT SETUP button does not reset the following settings:

- Language option
- Saved setup files
- Saved reference waveform files
- Display contrast
- Calibration data
- Printer setup
- RS232 setup
- GPIB setup

Appendix E: GPIB and RS-232 Interfaces

The next table provides an in-depth comparison of the GPIB and RS-232 interfaces. You should select the interface that best meets your requirements.

GPIB and RS-232 interface comparison

Operating attribute	GPIB	RS-232
Cable	IEEE-488 Std.	9-wire
Data flow control	Hardware, 3-wire handshake	Flagging: soft (XON/XOFF), hard (RTS/CTS)
Data format	8-bit parallel	8-bit serial
Interface control	Operator low-level control message	None
Interface messages	Most IEEE-488 Std.	Device clear using a break signal
Interrupts reported	Service requests, status and event code	None, must be polled for status

GPIB and RS-232 interface comparison (Cont.)

Operating attribute	GPIB	RS-232
Message termination (Receive)	Hardware EOL, software LF, or both	Software CR, LF, CRLF, LFCR
Message termination (Transmit)	Hardware EOL, software LF	Software CR, LF, CRLF, LFCR
Timing	Asynchronous	Asynchronous
Transmission path length (max)	≤ 4 meters between devices; ≤ 20 meters total cabling	≤ 15 meters
Speed	200 kBytes/sec	19,200 bits/sec
System environment	Multiple devices (≤ 15)	Single terminal (point-to-point connection)

Index

? in Value readout, 44

A

Abbreviating, commands, 150

AC coupling, 112

Accessories, 169–172

Acquire, menu, 74

ACQUIRE button, 38, 74

Acquire signals, basic concepts, 17

Acquisition

live display, 78

modes, 74

single-shot example, 56

stopping, 78

Acquisition mode, indicators, 28

Acquisition modes, 17

Average, 17

Peak Detect, 17

Sample, 17

Address, Tektronix, xiii

Aliasing

check for, 21

FFT, 122

time domain, 20

Application examples, 41

analyzing a differential communication signal, 68

analyzing signal detail, 54

automatic measurements, 42

autoset, using, 42

averaging, using, 55

calculating amplifier gain, 47

capturing a single-shot signal, 56

cursors, using, 48

looking at a noisy signal, 54

measuring propagation delay, 58

measuring pulse width, 50

measuring ring amplitude, 49

measuring ring frequency, 48

measuring rise time, 51

measuring two signals, 46

optimizing the acquisition, 57

peak detect, using, 54

reducing noise, 55

taking automatic measurements, 43

taking cursor measurements, 48

triggering on a specific pulse width, 60

triggering on a video signal, 62

triggering on video fields, 63

triggering on video lines, 64

using persistence, 72

using the math functions, 69

using the window function, 66

using XY mode, 72

viewing impedance changes in a network, 70

Attenuation, probe, 112

Auto trigger, 101

Automatic measurements

? in Value readout, 44

basic concepts, 25

AUTOSET, button, 38, 79

Autoset function, 12

overview, 79

pulse signal, 82

sine waves, 81

square wave, 82

video signal, 83

Average, 74, 77

Average mode, 17

B

- Bandwidth, limit, 112
- Bandwidth limited, readout, 30
- Bezel button, xi
- Binary data, RS-232 transfer, 141
- Break signals, RS-232 protocol, 142
- Burst waveforms, 117

C

- Calibration, 110
 - automatic routine, 10
- Centronics port, 131
- CH 1
 - connector, 39
 - MENU button, 34
- CH 2
 - connector, 39
 - MENU button, 34
- CH 3
 - connector, 39
 - MENU button, 34
- CH 4
 - connector, 39
 - MENU button, 34
- Channel, scale, 30
- Cleaning, 173
- Coarse resolution, 112
- Command, abbreviating, 150
- Communications module. *See* *TDS2CMA module*
- Compensation
 - probe, manual, 8
 - Probe Check Wizard, 7
 - PROBE COMP connector, 39
 - signal path, 111
- Connectors
 - CH 1, CH 2, CH 3 and CH 4, 39
 - EXT TRIG, 39

- PROBE COMP, 39
- Contacting Tektronix, xiii
- Context-sensitive help topics, ix
- Contrast, 86
- Conventions used in this manual, xi
- Coupling
 - trigger, 15, 100, 103
 - vertical, 112, 113
- Cursor, menu, 84
- CURSOR button, 38, 84
- CURSOR position knobs, 34
- Cursors
 - adjusting, 38
 - application example, 48
 - basic concepts, 25
 - measurements, 48
 - measuring an FFT spectrum, 126
 - time, 25
 - using, 84
 - voltage, 25

D

- DC coupling, 112
- Default setup
 - Edge trigger, 176
 - Pulse trigger, 177
 - recalling, 97
 - Video trigger, 176
- DEFAULT SETUP button
 - option and control settings, 175
 - retained option settings, 178
- Description, general, 1
- Display
 - contrast, 86
 - format, 86
 - intensity, 86
 - menu, 86
 - persistence, 86
 - readouts, 28
 - style (Invert), 112

type, 86
DISPLAY button, 38, 86
Display style of waveforms, 87
Do Self Cal option, 10
Dots, 86
Dual time base, 36, 90

E

Edge trigger, 100
Error Log, 110
EXT TRIG connector, 39
Extension module. *See TDS2CMA module*
External trigger connector, 39

F

Factory setup, 175
 recalling, 97
Features, overview, 2
FFT aliasing, 122
 remedies, 123
FFT spectrum
 applications, 115
 displaying, 118
 magnify, 124
 measuring magnitude and frequency with cursors, 126
 Nyquist frequency, 117
 process, 115
 readouts, 119
 Window, 120
FFT Window
 Flattop, 122
 Hanning, 122
 Rectangular, 122
FFT Zoom, 118
Fine resolution, 112

Flattop window, 122
FORCE TRIG button, 37
Format, 86
Frequency cursors, FFT spectrum, 126
Functional check, 5
Fundamental frequency component, 119

G

GPIB port, 131
 cable part numbers, 144
 connecting a cable, 144
 setup, 143
GPIB protocol
 compared to RS-232 standard, 179
 network configurations and connection guidelines, 148
 setup options, 144
 testing, 145
Graticule, 24, 86
Ground
 marker, 29
 probe terminal, 6
 terminals, 39
Ground coupling, 112
Ground lead for probe, 6

H

Hanning window, 122
HELP SCROLL LED, ix
Help System, ix
Helpful messages, 30
Holdoff, 92, 109

HOLDOFF control, 36
 access, push HORIZ MENU
 button, 109
HORIZ MENU button, 36
Horizontal
 aliasing, time domain, 20
 how to make large adjustment, 35
 menu, 90
 position, 19
 position marker, 29
 scale, 19
 status, 111
Hyperlinks in help topics, x

I

I/O errors, RS-232 report, 141
Index for help topics, x
Intensity, 86
Inverted waveform, readout, 30

L

Language, how to change, 1
Languages, 110
Level, 16, 36
LEVEL control, 36
Lissajous pattern, XY format, 88

M

Magnitude cursors, FFT spectrum,
 126
Main time base, 36, 90
Manuals, ordering, 170
Math
 FFT, 115, 118
 functions, 93
 menu, 93
MATH MENU button, 34

Measure, menu, 94
MEASURE button, 38
Measurements
 automatic, 25, 94
 basic concepts, 24
 cursor, 25, 48
 fall time, 95
 FFT spectrum, 126
 frequency, 94
 graticule, 24
 mean, 95
 negative width, 95
 peak-to-peak, 95
 period, 94
 positive width, 95
 rise time, 95
 RMS, 95
 types, 94

Menu system, using, 32

Menus

 Acquire, 74
 Cursor, 84
 Display, 86
 Horizontal, 90
 Math, 93
 Math FFT, 118
 Measure, 94
 Save/Recall, 97
 Trigger, 99
 Utility, 110
 Vertical, 112

Mercury, end-of-life handling, xii

Messages, 30, 31

N

Normal operation, recall default
 setup, 13
Normal trigger, 101
NTSC, 104
Nyquist, frequency, 117

O

- Option button, xi
- Options
 - Action type, 33
 - Circular List type, 32
 - Page Selection type, 32
 - Radio type, 33
- Oscilloscope
 - end-of-life handling, xii
 - front panels, 27
 - specifications, 151–164
 - understanding functions, 11

P

- P2200 probe specifications, 165–167
- PAL, 104
- Peak Detect mode, 17, 74, 76
- Persistence, 86, 88
- Phone number, Tektronix, xiii
- Ports, communications, 131
- Position
 - horizontal, 90
 - vertical, 112
- POSITION control
 - horizontal, 35
 - vertical, 34
- Positioning waveforms, basic concepts, 18
- Power, 4
- Power cords, 4
 - ordering, 171
- Pretrigger, 14
- Pretrigger view, 103
- PRINT button, 38, 96
- Printer, setup, 131
- Printing
 - screen data, 96, 133
 - testing the port, 133

- PROBE CHECK button, 7
- Probe Check Wizard, 7
- PROBE COMP connector, 39
- Probe option, match to probe attenuation, 9
- Probes
 - 1X attenuation and bandwidth limit, 9
 - attenuation, 112
 - Attenuation switch, 9
 - compensation, 8, 39
 - safety, 6
 - specifications, 165–167
- Product support, contact information, xiii
- Programmer manual, ordering, 170
- Pulse signal, Autoset function, 82
- Pulse width triggering, 105

R

- Readouts
 - FFT (Math), 119
 - general, 28
- Recall
 - factory setup (default), 13
 - setups, 12, 97
 - waveforms, 98
- Rectangular window, 122
- Reference waveforms
 - readout, 30
 - saving and recalling, 98
- Resolution, fine, 113
- RM2000 rackmount kit, ordering, 169
- Roll mode. *See scan mode*
- RS-232 port, 131
 - cable part numbers, 134
 - connecting a cable, 135
 - connector pinout, 142
 - setup, 134

RS-232 protocol
Break signals, 142
compared to GPIB standard, 179
conventions, 141
I/O errors, 141
setup options, 136
testing, 137
troubleshooting, 139
RUN/STOP button, 38, 77
steps taken by the oscilloscope
when pushed, 14

S

Sample mode, 17, 74, 75
Sample rate, maximum, 75
Save
setups, 12, 97
waveforms, 98
SAVE/RECALL button, 38, 97
Scaling waveforms, basic concepts,
18
Scan mode, 78, 92
Scanning waveform, 92, 101
Screen button, xi
Screen data
printing, 133
sending to an external device,
131
SEC/DIV control, 36, 91
SECAM, 104
Security loop, 4
Service, 110
Service manual, ordering, 170
Service support, contact informa-
tion, xiii
SET TO 50% button, 37
SET TO ZERO button, 36
Setups
basic concepts, 12
saving and recalling, 97

Side-menu button, xi
Signal path compensation, 111
Sine waves, Autoset function, 81
SINGLE SEQ button, 77
steps taken by the oscilloscope
when pushed, 14
Single-shot signal, application
example, 56
Slope, 16
Soft case, ordering, 171
Soft keys, xi
Source
AC Line, 102
Ext, 102
Ext/5, 102
trigger, 14, 100, 104, 105
Specifications
oscilloscope, 151–164
P2200 probe, 165–167
Square wave, Autoset function, 82
Status
miscellaneous, 111
system, 110
Sync pulse, 104

T

TDS2CMA module, 127
GPIB setup, 143
how to install and remove, 129
ordering, 169
printer setup, 131
RS-232 setup, 134
Technical support, contact informa-
tion, xiii
Tektronix, contacting, xiii
Time base, 18
Main, 36, 90
readout, 30
Window, 36, 90
Time cursors, 25, 84

Time domain , waveform, 116
Transient waveforms, 117
Transit case, ordering, 171
TRIG MENU button, 37
TRIG VIEW button, 37
Trigger
 coupling, 15, 100, 103
 definition, 13
 edge, 100
 external, 104
 frequency readout, 30, 101, 106
 holdoff, 36, 92, 109
 level, 16, 36, 99
 level marker, 29
 level readout, 30
 menu, 99
 modes, 15
 Auto, 101
 Normal, 101
 polarity, 105
 position, 16
 position marker, 29
 position readout, 29
 pretrigger information, 103
 slope, 16, 100
 source, 14, 30, 100, 105
 status, 29, 111
 sync, 104
 type indicator, 30
 types, 15
 video, 104, 105
 view, 37, 104
Trigger
 source, 30

U

U in readout, 85
URL, Tektronix, xiii

USER SELECT knob, 36
 alternative functions, 107
 holdoff control, 109
Utility, menus, 110
UTILITY button, 38

V

Value readout, ? displays, 44
Vectors, 86
Vertical
 menu, 112
 position, 18
 scale, 18
 status, 111
Video signal, Autoset function, 83
Video trigger, 104
 application example, 62
Voltage cursors, 25, 84
VOLTS/DIV, math waveform, 93
Volts/Div
 Coarse, 112
 Fine, 112
VOLTS/DIV control, 34

W

Waveforms
 acquire data, 17
 burst, 117
 compression, 91
 digitized, 17
 display style meaning, 87
 expansion, 91
 position, 18
 remove from screen, 114
 saving and recalling, 98
 scale, 18

scanning, 78
take measurements, 24
time domain, 116
transient, 117
Web site address, Tektronix, xiii
Window time base, 36, 90
 readout, 30
Window Zone, 90, 92
Windows, FFT spectrum, 120

X

XY, display format, 86, 88

XY , application example, 72

Y

YT, display format, 86

Z

Zoom, FFT, 124